

BD FACSCelesta™ Flow Cytometer User's Guide

For Research Use Only

23-17147-02
9/2020



Becton, Dickinson and Company
BD Biosciences
2350 Qume Drive
San Jose, CA 95131 USA

bdbiosciences.com
ResearchApplications@bd.com

BD Biosciences
European Customer Support
Tel +32.53.720.600
help.biosciences@bd.com

Copyrights

© 2020, Becton, Dickinson and Company. All rights reserved. No part of this publication may be reproduced, transmitted, transcribed, stored in retrieval systems, or translated into any language or computer language, in any form or by any means: electronic, mechanical, magnetic, optical, chemical, manual, or otherwise, without prior written permission from BD Biosciences.

The information in this guide is subject to change without notice. BD Biosciences reserves the right to change its products and services at any time to incorporate the latest technological developments. Although this guide has been prepared with every precaution to ensure accuracy, BD Biosciences assumes no liability for any errors or omissions, nor for any damages resulting from the application or use of this information. BD Biosciences welcomes customer input on corrections and suggestions for improvement.

Trademarks

Clorox is a registered trademark of The Clorox Company.

SPHERO is a trademark of Spherotech, Inc.

Microsoft and Windows are registered trademarks of Microsoft Corporation.

Texas Red[®] and Alexa Fluor[®] are registered trademarks of Life Technologies Corporation.

Teflon is a registered trademark of E.I. du Pont de Nemours and Company.

Living Colors[®] (DsRed, mCherry) is a registered trademark of Clontech.

Cy[™] is a trademark of GE Healthcare. Cy[™] dyes are subject to proprietary rights of GE Healthcare and Carnegie Mellon University, and are made and sold under license from GE Healthcare only for research and in vitro diagnostic use. Any other use requires a commercial sublicense from GE Healthcare, 800 Centennial Avenue, Piscataway, NJ 08855-1327, USA.

Falcon[®] is a registered trademark of Corning Incorporated.

CF[™] is a trademark of Biotium, Inc.

BD, the BD Logo, FACS, FACSCelesta, FACSClean, FACSDiva and FACSFlow are trademarks of Becton, Dickinson and Company or its affiliates. All other trademarks are the property of their respective owners. © 2020 BD. All rights reserved.

Patents

APC-Cy7: US 5,714,386

Regulatory information

For Research Use Only. Not for use in diagnostic or therapeutic procedures.

Class 1 Laser Product.

FCC information

WARNING: Changes or modifications to this unit not expressly approved by the party responsible for compliance could void the user's authority to operate the equipment.

NOTICE: This equipment has been tested and found to comply with the limits for a Class A digital device, pursuant to Part 15 of the FCC Rules. These limits are designed to provide reasonable protection against harmful interference when the equipment is operated in a commercial environment. This equipment generates, uses, and can radiate radio frequency energy and, if not installed and used in accordance with the instruction manual, may cause harmful interference to radio communications. Operation of this equipment in a residential area is likely to cause harmful interference in which case the user will be required to correct the interference at his or her own expense. Shielded cables must be used with this unit to ensure compliance with the Class A FCC limits. This Class A digital apparatus meets all requirements of the Canadian Interference-Causing Equipment Regulations. Cet appareil numérique de la classe A respecte toutes les exigences du Règlement sur le matériel brouilleur du Canada.

Compliance information

NOTICE: This laboratory equipment has been tested and found to comply with the EMC and the Low Voltage Directives. This includes FCC, Part 15 compliance for a Class A Digital Device.

CAUTION: Any unauthorized modifications to this laboratory equipment may affect the Regulatory Compliance items stated above.

History

Revision	Date	Change made
23-17147-00	11/2015	Initial release
23-17147-01	6/2016	Updated the guide by removing status screen image and air pressure definition.
23-17147-02	9/2020	Removed references to FACSRinse and added BD Detergent Solution Concentrate in place of FACSRinse.

Contents

Chapter 1: About this guide	9
What this guide covers	10
Conventions	11
About the BD FACSCelesta documentation	11
Instrument technical support	13
Chapter 2: Introduction	15
System overview	16
Cytometer overview	17
Control panel	19
Fluidics system	20
Sheath and waste containers	27
Optics	28
Workstation	30
Chapter 3: Cytometer setup	31
Starting the cytometer and computer	32
Preparing the sheath container	33
Removing air bubbles	35
Preparing the waste container	38
Priming the fluidics	40
About the optical filters and mirrors	41
Custom configurations and baselines	43

Chapter 4: Maintenance	45
Maintenance overview	46
Cleaning the fluidics	47
Shutting down the cytometer	49
Flushing the system	50
Replacing the waste container cap	52
Changing the sheath filter	54
Changing the Bal seal	56
Changing the sample tube O-ring	58
Cleaning or replacing the sheath gasket	60
Chapter 5: Optimizing cytometer settings	61
Cytometer settings workflow	62
Verifying the configuration and user preferences	64
Running a performance check	67
Setting up an experiment	72
Creating application settings	77
Recording compensation controls	80
Calculating compensation	83
Chapter 6: Recording and analyzing data	85
Data recording and analysis workflow	86
Preparing the workspace	87
Recording data	88
Analyzing data	91
Reusing an analysis	97
Chapter 7: Technical overview	99
About fluidics	100
About optics	101
About electronics	112

Chapter 8: Troubleshooting	117
Cytometer troubleshooting	118
Electronics troubleshooting	126
Chapter 9: Detector array configurations	127
Fluorescence spectra	128
About configuration maps	131
About the configuration	132
Base configuration polygon maps	134
Chapter 10: Supplies and consumables	143
Ordering information	144
Beads	144
Reagents	145
Equipment	146
Index	147

1

About this guide

This chapter covers the following topics:

- [What this guide covers \(page 10\)](#)
- [Conventions \(page 11\)](#)
- [About the BD FACSCelesta documentation \(page 11\)](#)
- [Instrument technical support \(page 13\)](#)

What this guide covers





This guide describes the procedures necessary to operate and maintain your BD FACSCelesta™ flow cytometer. Because many cytometer functions are controlled by BD FACSDiva™ software, this guide also contains information about software features required for basic cytometer setup and operation.

This guide assumes you have a working knowledge of basic Microsoft® Windows® operation. If you are not familiar with the Windows operating system, see the documentation provided with your computer.

Conventions

Introduction The following table lists the safety symbols used in this guide to alert you to potential hazards.

Safety symbols

Symbol	Meaning
	Caution! Identifies a hazard or unsafe practice that could result in data loss, material damage, minor injury, severe injury, or death
	Biological hazard
	Electrical hazard
	Laser hazard

About the BD FACSCelesta documentation

Introduction This topic describes the documentation available with the BD FACSCelesta flow cytometer.

Publication formats This guide is provided in PDF format to provide an eco-friendly option. All content is also included in the BD FACSDiva software Help.

Help system The help system installed with BD FACSDiva software includes all content from this guide and the documents listed below. Access the BD FACSCelesta help system from the Help menu in the

BD FACSDiva software. Internet access is not required to use the help system.

The help system is compiled from the following documents:

- *BD FACSDiva Software Reference Manual*: Includes instructions or descriptions for installation and setup, workspace components, acquisition controls, analysis tools, and data management. Access this manual from the BD FACSDiva Software Help menu (Help > Documentation > Reference Manual), or by double-clicking the shortcut on the desktop.
- *BD FACSCelesta Flow Cytometer Site Preparation Guide*: Contains specifications for:
 - Cytometer weight and size
 - Temperature
 - Electrical requirements
- *BD High Throughput Sampler User's Guide*: Describes how to set up and operate the BD™ High Throughput Sampler (HTS) option. It also contains a description of BD FACSDiva software features specific to the HTS.
- *BD FACSTow™ Supply System User's Guide*: Describes the optional automated sheath and waste fluid control system.

**Additional
Documentation**

BD Cytometer Setup and Tracking Application Guide: Describes how to use the BD™ Cytometer Setup and Tracking (CS&T) features in BD FACSDiva software. You can find the document in the following location bdbiosciences.com/guide.

Instrument technical support

Introduction

This topic describes how to get technical assistance.

Contacting technical support

If technical assistance is required, contact your local BD Biosciences customer support representative or supplier.

When contacting BD Biosciences, have the following information available:

- Product name, part number, and serial number
- Version of BD FACSDiva software you are using
- Any error messages
- Details of recent system performance

To contact customer support:

1. Go to bdbiosciences.com.
 2. Select your region. You will see information in your local language.
 3. Click **Go**.
 4. Click the **Support** link for details for your local region.
-

This page intentionally left blank

2

Introduction

This chapter covers the following topics:

- [System overview \(page 16\)](#)
- [Control panel \(page 19\)](#)
- [Fluidics system \(page 20\)](#)
- [Sheath and waste containers \(page 27\)](#)
- [Optics \(page 28\)](#)
- [Workstation \(page 30\)](#)

System overview

About the system The BD FACSCelesta system includes the BD FACSCelesta flow cytometer, BD FACSDiva software v8.0.1.1 running on the system workstation, the optional BD FACSFlow™ supply system (FFSS), and the optional BD High Throughput Sampler (HTS). Each component is described in detail in the following sections.

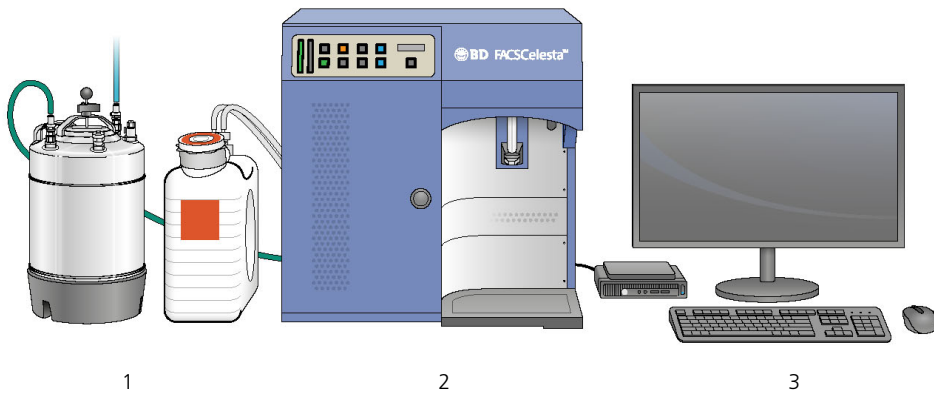

Number	Components
1	Sheath and waste tanks
2	BD FACSCelesta flow cytometer
3	Computer workstation

Cytometer overview

Introduction

The BD FACSCelesta flow cytometer is an air-cooled multi-laser benchtop flow cytometer with the ability to acquire 10–12 fluorescent parameters. It uses fixed-alignment lasers that transmit light through a flow cell to collect and translate the resulting fluorescence signals into electronic signals. Cytometer electronics convert these signals into digital data.

Components

The following figure shows the main components of the BD FACSCelesta flow cytometer, which are listed in the table. Each component is described in detail in the following sections.

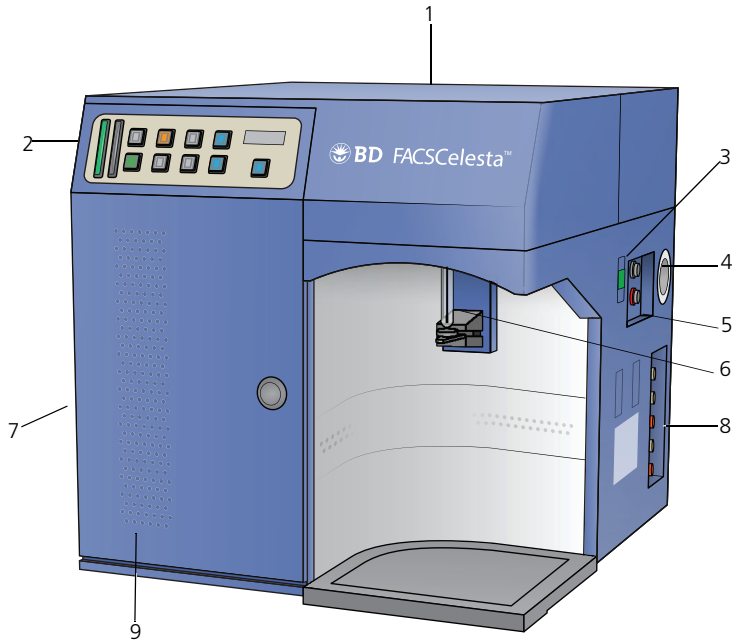

Number	Component
1	Heat ventilation slots (top)
2	Control panel
3	Power button
4	Electrical plug
5	Fluidic sensor ports
6	Sample injection port (SIP)
7	Heat ventilation slots (left side)
8	Air and fluidic ports
9	Optics access door (polygon detector arrays)



Caution! Do not place any objects on top of the instrument. Blocking the ventilation may cause the instrument to overheat.



Caution: Electrical Hazard! Do not place liquids on top of the instrument. Any spill of liquid into the ventilation openings could cause electrical shock or damage to the instrument.

Control panel

Overview

The following figure shows the components in the control panel, which are listed in the table.

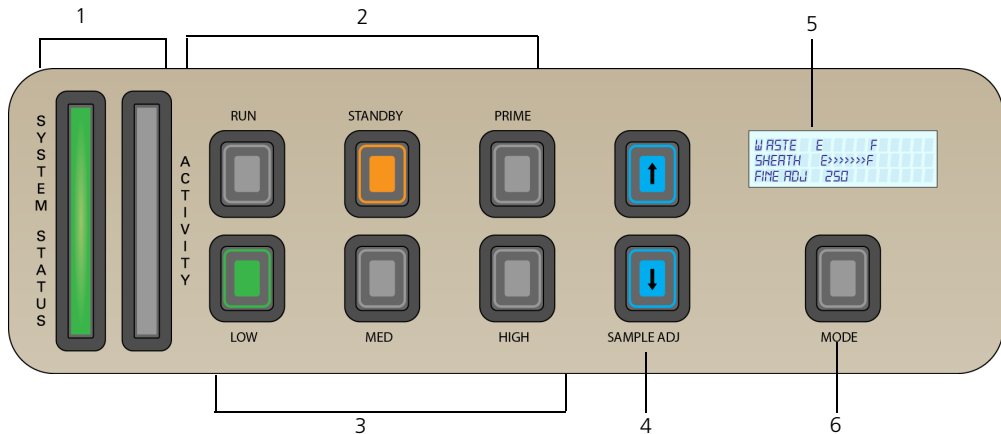

Number	Component
1	System indicators
2	Fluid control buttons
3	Sample flow rate buttons

Number	Component
4	Sample fine adjust buttons
5	Status screen
6	MODE button

- More information**
- [Fluidics system \(page 20\)](#)
 - [Optics \(page 28\)](#)

Fluidics system



Introduction

The fluidics system carries the sample out of the sample tube and into the interrogation region of the flow cell. Cells are carried in the sample core stream in single file and measured individually.

System indicators

There are two system indicators (System Status and Activity) on the control panel.

- **System Status.** Shows the status of the sheath and waste tank levels. The following table describes the LED indicators, conditions that trigger them, and any action that must be taken.

LED color	Status	Action	Condition
Green	Good	None	Good
Yellow	 Caution! Sheath and/or waste tanks need attention.	Check tank levels	Sheath low and/or waste nearly full
Red	 Caution! Take immediate action.	<ul style="list-style-type: none"> • Empty waste tank • Fill sheath tank 	Sheath empty and/or waste full

System status is also displayed on the Status screen. See [Status screen \(page 23\)](#) for a description of the Status screen.

- **Activity.** Shows whether the cytometer power is on and the status of acquisition. The following table describes the indicator LEDs, and status that triggers them.

Indicator	LED color	Status
Steady pulse	blue	Cytometer is powered on
Fluctuates	blue	Cells are passing through the flow cell

Fluid control

The three fluid control buttons (RUN, STANDBY, and PRIME) set the cytometer operation.

- **RUN.** Pressurizes the sample tube to transport the sample through the sample injection tube and into the flow cell.

The RUN button is green when the sample tube is on and the support arm is centered. When the tube support arm is moved left or right to remove a sample tube, the cytometer switches to an automatic standby status to conserve sheath fluid, and the RUN button changes to orange.

The RUN button will also turn orange if the sample tube is cracked or the BAL seal is bad. See [Troubleshooting \(page 117\)](#).

- **STANDBY.** Stops fluid flow to conserve sheath fluid.

When you leave the cytometer for more than a few minutes, place a tube containing less than 1 mL of deionized (DI) water on the sample injection port (SIP) and press STANDBY.

- **PRIME.** Prepares the fluidics system by draining and filling the flow cell with sheath fluid.

Note: Remove sample tubes during the prime cycle.

The fluid flow initially stops, and pressure is reversed to force fluid out of the flow cell and into the waste container. After a

preset time, the flow cell fills with sheath fluid at a controlled rate to prevent bubble formation or entrapment. At completion, the cytometer switches to standby mode.

Sample flow rate control

The three flow rate control buttons (LOW, MED, HIGH) set the sample flow rate through the flow cell. The SAMPLE ADJ buttons allow you to adjust the rate to intermediate levels.

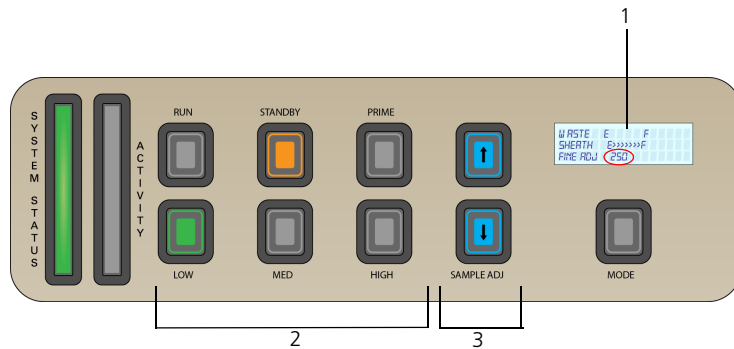

Number	Component
1	Status screen
2	Sample flow rate buttons
3	Sample fine adjust buttons

When sample adjust is set to 250 (as shown on the status screen on the control panel) the sample flow rates at the Low, Med, and High settings are approximately 12, 35, and 60 $\mu\text{L}/\text{min}$ of sample, respectively. Each time you press one of the SAMPLE ADJ buttons, the fine adjust of the indicated sample increases or decreases by 10.

The following table shows the approximate sample flow rate range for low, medium, and high.

Settings	Sample flow rate (µL/min)
Low	6–24
Med	17.5–70
High	30–120

Status screen

The status screen line toggles between two different displays and is described in detail in the following table.

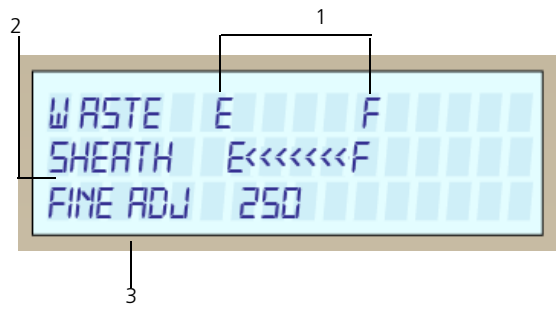

Line	Definition
1	Waste level. Shows range from E (empty) to F (full). The display line increases from left to right in sequences of 20%. System status turns yellow at 80%, and red at 100% full.
2	Sheath level. Shows range from E to F. The display line decreases from right to left in sequences of 20% from full level. System status turns yellow at 20%, and red at 0%.
3	Fine Adj. Shows the current setting of fine adjust. Fine adjust can be set in increments of 10 from 0 to 500. The normal set point is 250. The last value persists, even after cytometer shutdown.
4	HTS mode. Shows that the cytometer is in HTS mode. To enter this mode, press and hold down the MODE button for more than 3 seconds. Status information is not displayed and system status turns green. To return to the normal mode, press and hold the MODE button for more than 3 seconds

Fluidic alarms and the Mode button

The fluidic alarms are triggered by the waste and sheath fluid levels in the tanks. The alarms sound when the waste tank is nearly 100% full and the sheath tank is empty. The fluidic alarms and system status will also show warnings when you start up the cytometer until the tank pressure reaches the correct level.

To silence the alarm, press the MODE button, then press the Down button. The MODE button flashes to indicate the cytometer is in silent mode. Repeat this sequence to turn off silent mode.

Note: Turning the cytometer to silent mode may result in overflow of waste and you may run out of sheath.

Note: When the cytometer is in HTS mode, both visual and audible alarms will be deactivated.

Sample injection port (SIP)

The SIP is where the sample tube is installed. The SIP includes the sample injection tube and the tube support arm. Samples are introduced through a stainless steel injection tube equipped with an outer droplet containment sleeve. The sleeve works in conjunction with a vacuum pump to eliminate droplet formation of sheath fluid as it backflushes from the sample injection tube.

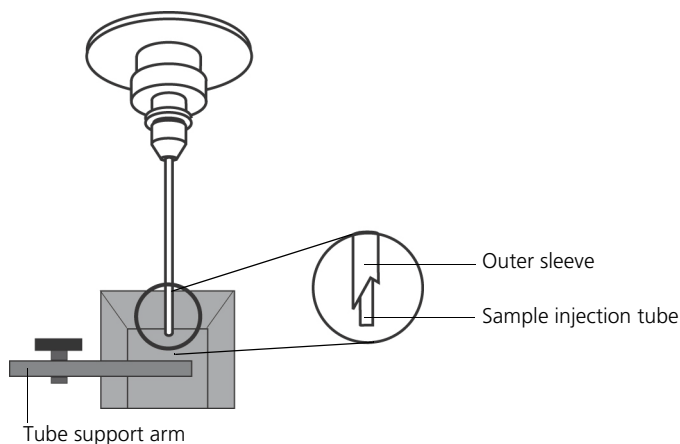

Sample injection tube. Stainless steel tube that carries sample from the sample tube to the flow cell. This tube is covered with an outer sleeve that serves as part of the droplet containment system.

Tube support arm. Arm that supports the sample tube and activates the droplet containment system vacuum. The vacuum is on when the arm is positioned to the side and off when the arm is centered.

Note: If a sample tube is left on the SIP with the tube support arm to the side (vacuum on), the sample will be aspirated into the waste container.

Cautions when using the HTS option



Caution: Biohazard! When using the BD FACSCelesta flow cytometer with the HTS, ensure that the HTS is completely pushed into the operating position before removing the droplet containment module (DCM) sleeve or disconnecting the sample coupler from the SIP. This is to avoid accidental leakage of potentially biohazardous liquids directly onto the instrument. With the HTS in the proper location, the containment dish with padding is directly below the SIP.



Caution! If you are using the HTS option, always slide the HTS mount slowly to prevent sample cross-contamination when the wells are full. Never move the HTS when it is in operation.



Caution! Do not lean on or put any weight on the HTS as it could damage the instrument.

Droplet containment module

The DCM prevents sheath fluid from dripping from the SIP and provides biohazard protection.

The DCM vacuum is activated when the tube support arm is moved to the side. Sheath fluid is aspirated as it backflushes the sample injection tube. This backflush helps prevent carryover of cells between samples.

Sheath and waste containers

Introduction

This topic describes the sheath and waste containers. The sheath and waste containers are outside the cytometer and can be positioned on the floor.

Note: Only BD service engineers should change the location of the sheath and waste tanks.

If you are using the BD FACSSlow™ supply system (FFSS), see the documentation provided.

Sheath container

The sheath container has a capacity of 10 L. Sheath fluid is filtered through an in-line, interchangeable filter that prevents small particles from entering the sheath fluid lines. An alarm sounds when the container is empty.



Caution! Do not fill the sheath tank to its maximum capacity. When an overfull tank is pressurized, erratic cytometer performance can result.

Waste container

The waste container has a capacity of 10 L. An alarm sounds when the container is full.

More information

- [Preparing the sheath container \(page 33\)](#)
 - [Preparing the waste container \(page 38\)](#)
 - [Status screen \(page 23\)](#)
 - [Fluidic alarms and the Mode button \(page 24\)](#)
-

Optics

Introduction

This topic describes the optical components for the BD FACSCelesta flow cytometer including:

- Detector arrays
 - Laser options
 - Optical filters
 - Signal detectors
-

Detector arrays

The BD FACSCelesta detector arrays consist of polygons. Each polygon can be outfitted with two to six fluorescent detectors and can detect up to six fluorescent signals.

Laser options

The BD FACSCelesta flow cytometer can be configured with up to three lasers as listed in the following table.

Lasers	Wavelength (nm)	Power (mW)
Violet (standard)	405	50
Blue (standard)	488	20
UV (optional)	355	15
Yellow Green (optional)	561	50
Red (optional)	640	40

Optical filters

Optical filters attenuate light or help direct it to the appropriate detectors. The name and spectral characteristics of each filter appear on its holder.

There are two types of optical filters in the BD FACSCelesta:

- **Longpass dichroic filters (LPs).** Transmit wavelengths at or longer than the specified value and reflect all light below the specified wavelength.

- **Bandpass filters (BPs).** Pass a narrow spectral band of light.

When dichroic filters are used as steering optics to direct different color light signals to different detectors, they are called dichroic mirrors. Longpass dichroic mirrors transmit longer wavelengths to one detector while reflecting shorter wavelengths to a different detector.

The BD FACSCelesta flow cytometer polygon detector arrays use dichroic longpass mirrors on the inside, and bandpass filters on the outside of the filter holders.

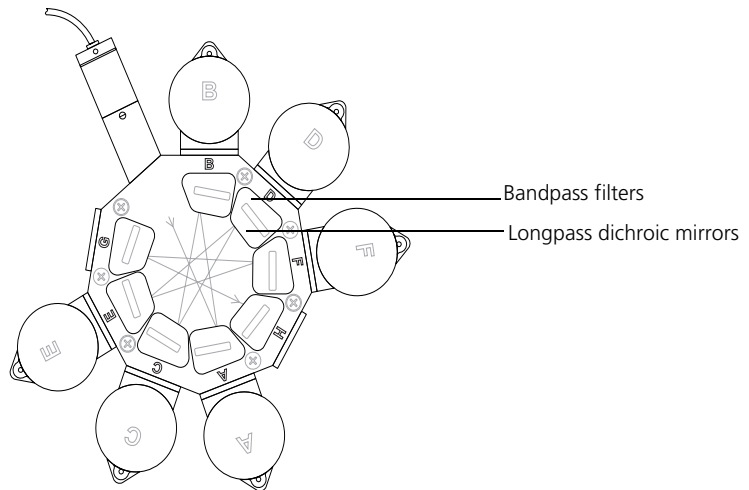

Signal detectors

Light signals are generated as particles pass through the laser beam in a fluid stream. When these optical signals reach a detector, electrical pulses are created that are then processed by the electronics system.

There are two types of signal detectors in the BD FACSCelesta flow cytometer:

- **Photomultiplier tubes (PMTs).** Used to detect the weaker signals generated by side scatter and all fluorescence channels. These signals are amplified by applying a voltage to the PMTs.

- **Photodiodes.** Less sensitive to light signals than the PMTs. A photodiode is used to detect the stronger forward scatter (FSC) signal.
-

More information

- [Optical filter theory \(page 104\)](#)
 - [About the configuration \(page 132\)](#)
-

Workstation

Introduction

This topic describes the components of the BD FACSCelesta workstation.

Workstation components

Acquisition, analysis, and most instrument functions are controlled by the BD FACSCelesta workstation. It includes a PC and one or two monitors.

Your workstation is equipped with the following:

- Microsoft Windows operating system
 - BD FACSDiva software version 8.0.1.1 or later for data acquisition and analysis
 - Software documentation including the help system
-

More information

- [About the BD FACSCelesta documentation \(page 11\)](#)
-

3

Cytometer setup

This chapter covers the following topics:

- [Starting the cytometer and computer \(page 32\)](#)
- [Preparing the sheath container \(page 33\)](#)
- [Removing air bubbles \(page 35\)](#)
- [Preparing the waste container \(page 38\)](#)
- [Priming the fluidics \(page 40\)](#)
- [About the optical filters and mirrors \(page 41\)](#)
- [Custom configurations and baselines \(page 43\)](#)

Starting the cytometer and computer

Introduction

This topic describes how to start the cytometer and turn on the computer.

Note: If your system is using the BD FACSTFlow supply system, make sure that the BD FACSTFlow supply system is powered on before the cytometer.

Procedure

To start the cytometer:

1. Turn on the power to the flow cytometer.

Allow 30 minutes for the optical system temperature to stabilize.



Caution! Failure to warm up and stabilize the instrument could affect sample data.

2. Turn on the computer and log in to Windows.

Note: You can turn on the power to the flow cytometer and the workstation in any order.

3. Start BD FACSDiva software by double-clicking the shortcut on the desktop, and log in to the software.
4. Check the **Cytometer** window in BD FACSDiva software to ensure that the cytometer is connected to the workstation.

The cytometer connects automatically. While connecting, the message *Cytometer Connecting* is displayed in the status area of the Cytometer window. When connection completes, the message changes to *Cytometer Connected*.

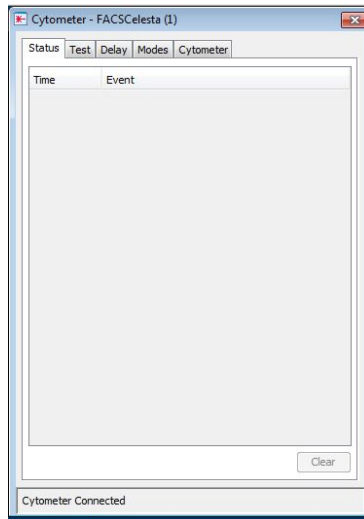

If the message *Cytometer Disconnected* appears, see [Electronics troubleshooting \(page 126\)](#).

Preparing the sheath container

Introduction

This topic describes how to prepare the sheath container.

Note: If your system is using the BD FACSCFlow supply system, see the documentation provided with your system.

When to check the sheath container

Check the fluid levels in the sheath container every time you use the cytometer. This ensures that you do not run out of sheath fluid during an experiment.

Sheath container components

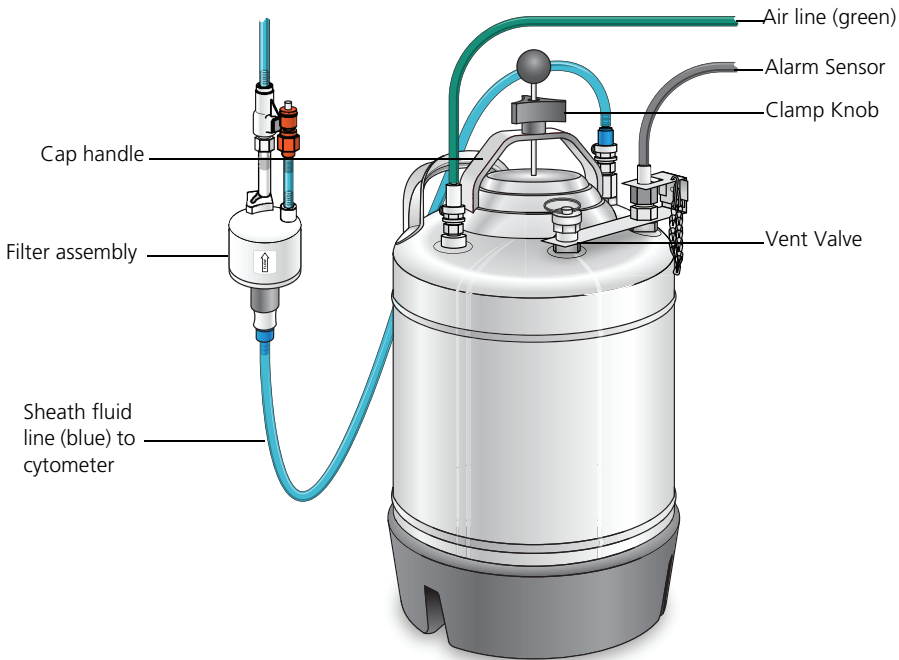

Procedure

To prepare the sheath container:

1. Verify that the flow cytometer is in standby mode.
Press the **STANDBY** button on the control panel if necessary.
2. Disconnect the green air line and blue sheath fluid line from the sheath container.
3. Disconnect the alarm line from the alarm sensor socket by pulling lightly on both ends of the plug.
4. Depressurize the sheath container by pulling up on the vent valve.

5. Remove the sheath container lid.

Unscrew the clamp knob and push down to loosen, if necessary. Tilt the cap to the side to remove it from the tank.

6. Add up to 10 L of sheath fluid, such as BD FACSTFlow solution, to the sheath container.

Note: 10 L will reach the interior line on the sheath tank. Do not fill the sheath tank further.

7. Replace the sheath container lid.

8. Make sure the gasket on the inside lip of the sheath lid is seated correctly and has not slipped out of position.

Note: If the gasket is not seated correctly, the tank will not pressurize properly.

9. Close the sheath lid and tighten the clamp knob to finger-tight.

10. Reconnect the green air line, alarm line and the blue sheath line.

Note: Ensure that the blue sheath fluid line is not kinked.

More information

- [Removing air bubbles \(page 35\)](#)
 - [Changing the sheath filter \(page 54\)](#)
 - [Cleaning or replacing the sheath gasket \(page 60\)](#)
-

Removing air bubbles

Introduction

This topic describes how to remove trapped air bubbles in the sheath filter and the sheath line. Air bubbles can occasionally dislodge and pass through the flow cell, resulting in inaccurate data.

Note: Perform this activity every time the sheath tank is refilled.

Procedure

To remove air bubbles:

1. Check the sheath filter for trapped air bubbles.

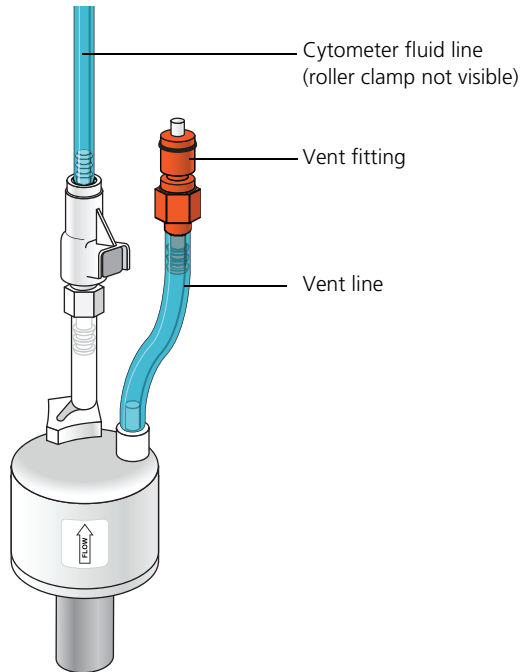

2. If bubbles are visible, gently tap the filter body with your fingers to dislodge the bubbles and force them to the top.



Caution! When removing air bubbles, do not vigorously shake, bend, or rattle the sheath filter or you might damage it.

3. Direct the vent line into a beaker and press the small button at the end of the vent fitting against the side of the beaker until a steady stream of fluid empties from the filter.

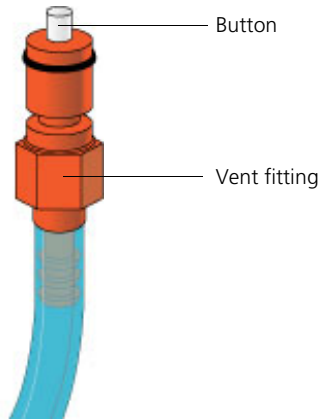

4. Tilt the filter and verify that no trapped air remains in the filter.
5. Repeat steps 3 and 4 until no air is observed in the filter.
6. Check the sheath line for air bubbles.
7. Open the roller clamp at the fluidics interconnect (if necessary) to bleed off any air in the line. Collect any excess fluid in a waste container.

Note: The roller clamp can be found close to the fluidics ports of the cytometer.

8. Close the roller clamp.
-

Preparing the waste container

Introduction

This topic describes how to prepare the waste container. Prevent waste overflow by emptying the waste container daily or whenever the system status indicator turns yellow.

Note: If your system is connected to the FFSS, see the documentation provided with your FFSS.



Caution: Biohazard! All biological specimens and materials coming into contact with them are considered biohazardous. Handle as if capable of transmitting disease. Dispose of waste using proper precautions and in accordance with local regulations. Never pipette by mouth. Wear suitable protective clothing, eyewear, and gloves.

Waste container components

The following figure shows the main components of the waste container.



Biological precautions



Caution: Biohazard! Contact with biological specimens and materials can transmit potentially fatal disease.

To prevent exposure to biohazardous agents:

- Put the cytometer in standby mode before disconnecting the waste tank to avoid leakage of biohazardous waste.
- Always disconnect the waste container from the cytometer before you empty it. Wait at least 30 seconds for pressure to dissipate before you remove the waste cap or sensor.
- Expose waste container contents to bleach (10% of total volume) for 30 minutes before disposal.
- Do not wet the waste tank cap. If wet, the filter in the cap will cause the tank to malfunction. To keep the cap dry, place it on the bench label side up when it is not on the tank.

Procedure

To prepare the waste container:

1. Verify that the flow cytometer is in standby mode.
Press the STANDBY button on the control panel if necessary.
2. Disconnect the orange waste tubing from the waste container.
3. Disconnect the black alarm sensor line from the alarm sensor socket.

Keep the lid and moisture trap on the waste container until you are ready to empty it.

4. Remove the lid and moisture trap before emptying the waste container. Keep the cap label side up at all times. Empty the waste container.



Caution! The waste container is heavy when full. When emptying it, use good body mechanics to prevent injury.

5. Add approximately 1 L of bleach to the waste container and close it. Reattach the moisture trap and lid.

6. Reconnect the orange waste tubing and make sure it is not kinked.
 7. Reconnect the black alarm sensor line.
-

Priming the fluidics

Introduction This topic describes how to prime the fluidics system.

When to prime the fluidics Sometimes, air bubbles and debris may become lodged in the flow cell. This is indicated by excessive noise in the forward and side scatter parameters (FSC and SSC, respectively). In these cases, it is necessary to prime the fluidics system.

Procedure **To prime the fluidics:**

1. Move the tube support arm to the side.
2. Remove the tube from the SIP.
3. Press the PRIME fluid control button to force the fluid out of the flow cell and into the waste container.

Once drained, the flow cell automatically fills with sheath fluid at a controlled rate to prevent bubble formation or entrapment. The STANDBY button turns amber after completion.
4. Repeat the priming procedure, if necessary.
5. Install a 12 x 75-mm tube with less than 1 mL of DI water on the SIP and place the support arm under the tube. Leave the cytometer in standby mode.

More information • [Cytometer troubleshooting \(page 118\)](#)

About the optical filters and mirrors

Introduction

This topic provides a description of the optical filters and mirrors.

Filter and mirror configurations

Each detector has an optic holder in front of it. The optic holders are labeled with numbers indicating the wavelengths of the bandpass filter and longpass dichroic mirror they contain (for example, 780/60 and 750 LP, respectively). The optic holder in front of the last detector in the detector array contains only a bandpass filter and is marked accordingly.

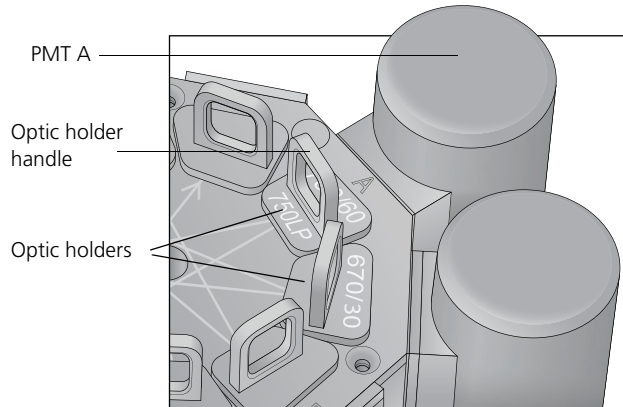

The filters steer progressively shorter wavelengths of light to the next detector in the array as indicated by the lines and arrows on the top of the polygon.

Optic holders, filters, and mirrors

Optic holders house filters and mirrors. Your cytometer includes several blank (empty) optic holders.



Caution! To ensure data integrity, do not leave any slots empty in a detector array when you are using the associated laser. Always use a blank optic holder.



Caution! Do not remove or change filters. Only BD authorized personnel should remove or change the filters.

Base configurations Each BD FACSCelesta flow cytometer has a base cytometer configuration that corresponds to the layout of the installed lasers and optics in your cytometer. This base configuration is set by your field service engineer.

BD FACSDiva cytometer configuration

Before you acquire data using BD FACSDiva software, you must specify a cytometer configuration. The cytometer configuration defines which filters and mirrors are installed at each detector.

BD FACSDiva software provides a BD base configuration for your BD FACSCelesta flow cytometer. Select Cytometer > View Configuration to create, modify, or delete custom cytometer configurations. (See the Cytometer and Acquisition Controls chapter of the *BD FACSDiva Software Reference Manual* for details.)

More information

- [About the configuration \(page 132\)](#)
-

Custom configurations and baselines

Introduction This topic describes where to find information on how to create a custom configuration and define a baseline for a performance check.

Overview BD Cytometer Setup and Tracking (CS&T) software is used to define the baseline performance of your cytometer. A baseline provides a starting point for the tracking of cytometer performance. When running a performance check, you compare the results to the baseline.

See [Optimizing cytometer settings \(page 61\)](#). Please see the latest published filter guides available on our website (bdbiosciences.com) for more information.

See the *BD Cytometer Setup and Tracking Application Guide* for information on creating custom configurations and defining a baseline.

More information

- [Running a performance check \(page 67\)](#)

This page intentionally left blank

4

Maintenance

This chapter covers the following topics:

- [Maintenance overview \(page 46\)](#)
- [Cleaning the fluidics \(page 47\)](#)
- [Shutting down the cytometer \(page 49\)](#)
- [Flushing the system \(page 50\)](#)
- [Replacing the waste container cap \(page 52\)](#)
- [Changing the sheath filter \(page 54\)](#)
- [Changing the Bal seal \(page 56\)](#)
- [Changing the sample tube O-ring \(page 58\)](#)
- [Cleaning or replacing the sheath gasket \(page 60\)](#)

Maintenance overview

Introduction

This topic provides an overview of the BD FACSCelesta flow cytometer routine maintenance and cleaning procedures.

General use guidelines



Caution: Biohazard! Contact with biological specimens and materials can transmit potentially fatal disease.

Follow these guidelines whenever operating or maintaining the cytometer:

- Wear suitable protective clothing, eyewear, and gloves.
- Handle all biological specimens and materials in accordance with applicable regulations and manufacturer specifications.
- Dispose of waste using proper precautions and in accordance with local regulations.
- Never pipette by mouth.

For fluidics maintenance, we recommend the following cleaning solutions:

- BD™ FACSClean solution
- 1.5% BD Detergent Solution Concentrate
- 10% bleach solution

Use DI water to dilute bleach to appropriate concentrations.



Caution! Higher concentrations of bleach and use of other cleaning solutions might damage the cytometer.

When to perform maintenance procedures

Perform maintenance procedures in the following frequencies.

Frequency	Maintenance procedure
Daily	<ul style="list-style-type: none"> • Cleaning the fluidics (page 47) • Shutting down the cytometer (page 49)
Scheduled (every two weeks)	<ul style="list-style-type: none"> • Flushing the system (page 50)
Periodic (frequency depends on how often you run the cytometer)	<ul style="list-style-type: none"> • Changing the sheath filter (page 54) • Changing the Bal seal (page 56) • Changing the sample tube O-ring (page 58) • Cleaning or replacing the sheath gasket (page 60)

Cleaning the fluidics

Introduction

This topic describes how to perform the daily fluidics cleaning.

Overview

Cleaning the fluidics daily prevents the sample injection tube from becoming clogged and removes dyes that can remain in the tubing.

In addition to daily cleaning, follow this procedure immediately after running viscous samples or nucleic acid dyes such as Hoechst, DAPI, propidium iodide (PI), acridine orange (AO), or thiazole orange (TO).

Procedure

To clean the fluidics:

1. Press RUN and HIGH on the cytometer fluid control panel.
2. Install a tube containing 3 mL of a 10% bleach solution on the SIP with the support arm to the side (vacuum on) and let it run for 1 minute.

See [Maintenance overview \(page 46\)](#) for other recommended cleaning solutions.

3. Move the tube support arm under the tube (vacuum off) and allow the cleaning solution to run for 5 minutes with the sample flow rate set to HIGH.
4. Repeat steps 2 and 3 with 1.5% BD Detergent Solution Concentrate.

Note: The BD Detergent Solution Concentrate must be diluted before use. 1.5% BD Detergent Solution is made from BD Detergent Solution Concentrate, 15 mL diluted to make 1 L total.



Caution: Biohazard! Never mix BD Detergent Solution and bleach because they can create dangerous fumes.

5. Repeat steps 2 and 3 with DI water.
6. Press the STANDBY button on the fluidics control panel.
7. Place a tube containing less than 1 mL of DI water on the SIP.

A tube with less than 1 mL of DI water should remain on the SIP to prevent salt deposits from forming in the injection tube. This tube also catches back drips from the flow cell.



Caution! Do not leave more than 1 mL of water on the SIP. When the instrument is turned off or left in standby mode, a small amount of fluid will drip back into the sample tube. If there is too much fluid in the tube, it could overflow and affect the cytometer performance.

Shutting down the cytometer

Introduction	This topic describes how to shut down the cytometer.
Before you begin	Each time you shut down the cytometer, perform the daily cleaning as described in Cleaning the fluidics (page 47) .
Procedure	<p>To shut down the cytometer:</p> <ol style="list-style-type: none">1. Place a tube of DI water on the SIP.2. Turn off the flow cytometer.3. Close FACSDiva software.4. Select Start > Shutdown to turn off the computer (if needed).5. If your system is connected to the FFSS, shut off the FFSS. <p>If the cytometer will not be used for a week or longer, perform a system flush and leave the fluidics system filled with DI water to prevent saline crystals from clogging the fluidics.</p>
More information	<ul style="list-style-type: none">• Cleaning the fluidics (page 47)• Flushing the system (page 50)

Flushing the system

Introduction

This topic describes how to perform an overall fluidics cleaning to remove debris and contaminants from the sheath tubing, waste tubing, and flow cell. Perform the system flush at least every 2 weeks.

Note: If you are using the BD FACSTFlow supply system, see the *BD FACSTFlow Supply System User's Guide* for instructions on flushing the system.

Cautions



Caution: Biohazard! The cytometer hardware might be contaminated with biohazardous material. Use 10% bleach to decontaminate the instrument.

Procedure

To perform a system flush:

1. Remove the sheath filter.
 - a. Press the quick-disconnects on both sides of the filter assembly.
 - b. Remove the filter assembly.
 - c. Connect the two fluid lines.



Caution! Do not run detergent, bleach, or ethanol through the sheath filter. They can break down the filter paper within the filter body, causing particles to escape into the sheath fluid, possibly clogging the flow cell.

2. Empty the sheath container and rinse it with DI water.
3. Fill the sheath container with at least 1 L of BD FACSClean solution.
4. Empty the waste container, if needed.
5. Open the roller clamp by the fluidics interconnect, and drain the fluid into a beaker for 5 seconds.

6. Remove the DI water tube from the SIP.
7. Prime the instrument twice:
 - a. Press the PRIME button on the fluidics control panel.
 - b. When the STANDBY button light is amber, press the PRIME button again.
8. Install a tube with 3 mL of BD FACSClean solution on the SIP and put the tube support arm underneath the tube.

See [Maintenance overview \(page 46\)](#) for other recommended cleaning solutions.
9. Press RUN and HIGH on the cytometer fluid control panel. Ensure that the sample fine adjust is set to 250. Run for 30 minutes.
10. Press the STANDBY fluid control button and depressurize the sheath container by lifting the vent valve.
11. Empty the waste tank to avoid the mixing of Bleach and BD Detergent Solution.
12. Repeat steps 2 through 11 with 1.5% BD Detergent Solution Concentrate.



Caution: Biohazard! Never mix BD Detergent Solution and bleach because they can create dangerous fumes.

13. Repeat steps 2 through 11 with DI water.
 14. Replace the sheath filter and refill the sheath container with sheath fluid.
 15. Install a tube with less than 1mL DI water onto the SIP.
-

Replacing the waste container cap

Introduction

This topic describes how to replace the waste container cap. Replace the cap once a month.

Biological precautions



Caution: Biohazard! Contact with biological specimens and materials can transmit potentially fatal disease.

To prevent exposure to biohazardous agents:

- Put the cytometer in standby mode before disconnecting the waste tank to avoid leakage of biohazardous waste.
 - The waste container can become pressurized when the cytometer is running. Always disconnect the waste container from the cytometer before you empty it. Wait at least 30 seconds for pressure to dissipate before you remove the waste cap or sensor.
 - Expose waste container contents to bleach (10% of total volume) for 30 minutes before disposal.
-

Procedure

To replace the cap:

1. Put the cytometer in standby mode.
2. Disconnect the orange waste line from the waste container tank.
3. Disconnect the alarm sensor line from the alarm sensor socket.
Note: Wait at least 30 seconds for pressure to dissipate.
4. Remove the waste cap and attached trap from the container and place on the bench label-side up.
5. Detach the cap from the trap.
6. Place a new cap on the trap.

7. Write the date on the cap label.

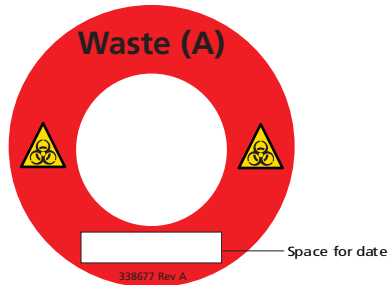

8. Screw the cap assembly onto the waste container and hand-tighten until it is fully closed.



Caution: Biohazard! To prevent waste container overpressurization, do not overtighten the trap or attached filter cap. Tighten each component only until it is hand-tight. Do not use sealants such as Teflon® tape or other adhesives.

Re-attach the alarm sensor line and waste line to the waste container tank.

Changing the sheath filter

Introduction

This topic describes how to change the sheath filter. The sheath filter is connected in-line with the sheath line. It filters the sheath fluid as it comes from the sheath container.

When to change the sheath filter

We recommend changing the sheath filter assembly every six months. Increased debris appearing in an FSC vs SSC plot can indicate that the sheath filter needs to be replaced. See [Supplies and consumables \(page 143\)](#) for ordering information.

Sheath filter components

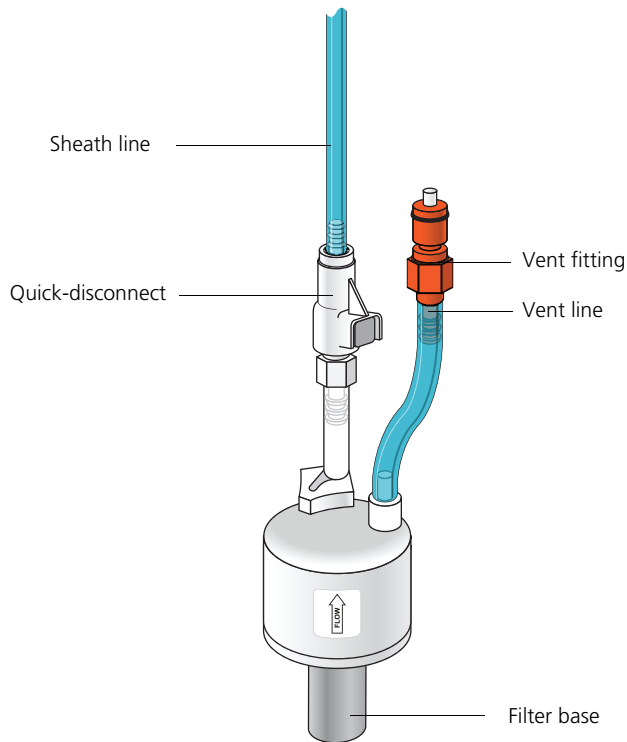

Removing the old filter**To remove the old filter:**

1. Place the cytometer in standby mode.
 2. Remove the sheath filter assembly by pressing the quick-disconnect on both sides of the filter assembly.
 3. Over a sink or beaker:
 - Remove the vent line from the filter and set it aside.
 - Remove the filter base and set it aside.
 4. Discard the used filter assembly in an appropriate receptacle.
-

Attaching the new filter**To attach the new filter:**

1. Connect the vent line to the new filter assembly.
Twist to attach.
 2. Wrap Teflon® tape around the filter threads, then connect the filter to the filter base.
 3. Connect the sheath line to the filter assembly by squeezing the quick-disconnect.
 4. Attach the cytometer fluid line to the filter assembly via the quick-disconnect.
 5. Direct the vent line into a beaker and press the small button at the end of the vent fitting against the side of the beaker until a steady stream of fluid empties from the filter.
 6. Tilt the filter and verify that no trapped air remains in the filter.
 7. Repeat steps 5 and 6 as necessary to remove all trapped air.
-

Changing the Bal seal

Introduction

This topic describes how to replace the Bal seal.

The sample injection tube Bal seal is a ring that forms a seal with the sample tube and ensures proper tube pressurization.

When to change the Bal seal

Over time, the Bal seal becomes worn or cracked and requires replacement. Replacement is necessary if a proper seal is not formed when a sample tube is installed on the SIP. Indications that a proper seal has not formed include:

- The tube will not stay on the SIP without the tube support arm.
 - When the tube is installed and RUN is pressed on the cytometer, the RUN button is orange (not green).
-

Caution



Caution: Biohazard! Cytometer hardware might be contaminated with biohazardous material. Wear suitable protective clothing, eyewear, and gloves whenever cleaning the cytometer or replacing parts.

Procedure

To replace the Bal seal:

1. Remove the outer sleeve from the sample injection tube by turning the retainer counter-clockwise. Slide the outer sleeve down and off of the sample injection tube.

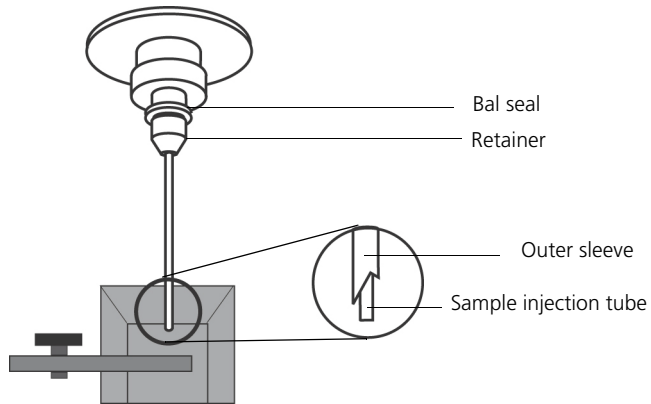

Work carefully. The outer sleeve can fall off as you loosen the retainer.

2. Remove the Bal seal by gripping it between your thumb and index finger and pulling down.

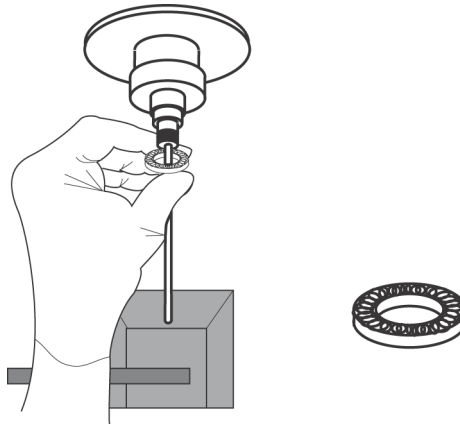

3. Install the new Bal seal spring-side up.

Ensure that the sample tube O-ring is still in place inside the retainer.

4. Re-install the retainer and outer sleeve over the sample injection tube. Push the outer sleeve all the way up into the sample injection port and then screw the retainer into place and tighten to finger tight. This will seat the Bal seal.
5. Install a sample tube on the SIP to ensure that the outer sleeve has been properly installed.

If the sleeve hits the bottom of the tube, loosen the retainer slightly and push the sleeve up as far as it will go. Tighten the retainer.

Changing the sample tube O-ring

Introduction

This topic describes how to replace the sample tube O-ring.

The sample tube O-ring, located within the retainer, forms a seal that allows the droplet containment vacuum to function properly.

When to replace the O-ring

Replace the O-ring when droplets form at the end of the sample injection tube while the vacuum is operating.

Caution



Caution: Biohazard! Cytometer hardware might be contaminated with biohazardous material. Wear suitable protective clothing, eyewear, and gloves whenever cleaning the cytometer or replacing parts.

Procedure

To change the O-ring:

1. Remove the outer sleeve from the sample injection tube by turning the retainer counter-clockwise.

2. Slide the outer sleeve from the retainer.

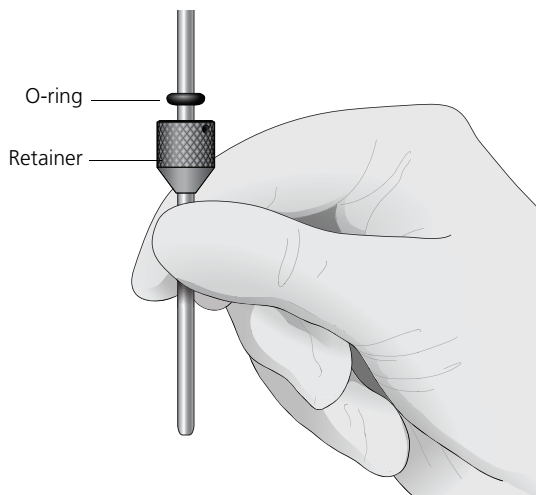

3. Invert the outer droplet sleeve and allow the O-ring to fall onto the benchtop.

If the O-ring does not fall out initially, hold the O-ring with your free hand and slide the outer sleeve to remove the O-ring.

4. Place the new O-ring into the retainer. Make sure the O-ring is seated properly in the bottom of the retainer.
5. Replace the outer sleeve in the retainer.
6. Re-install the retainer and the outer sleeve.
7. Install a sample tube on the SIP to ensure that the outer sleeve has been properly installed.

If the sleeve hits the bottom of the tube, loosen the retainer slightly and push the sleeve up as far as it will go. Tighten the retainer.

Cleaning or replacing the sheath gasket

Introduction This topic describes how to clean or replace the gasket of the sheath tank lid.

When to change the sheath gasket We recommend cleaning the sheath gasket when needed.

Procedure To clean or replace the gasket:

1. Put the cytometer in standby mode.
2. Depressurize the sheath container by pulling up on the vent valve.
3. Remove the lid from the sheath tank.
4. Remove the black gasket from the lid.
5. Rinse it with water to clean the gasket.
6. Place the clean gasket or the new gasket on the lid and make sure the gasket is seated properly on the lid.

5

Optimizing cytometer settings

This chapter covers the following topics:

- [Cytometer settings workflow \(page 62\)](#)
- [Verifying the configuration and user preferences \(page 64\)](#)
- [Running a performance check \(page 67\)](#)
- [Setting up an experiment \(page 72\)](#)
- [Creating application settings \(page 77\)](#)
- [Recording compensation controls \(page 80\)](#)
- [Calculating compensation \(page 83\)](#)

Cytometer settings workflow

Introduction This topic describes how to optimize cytometer settings. The optimization is performed using the Cytometer Setup and Tracking, Application Settings, and Compensation Setup features of BD FACSDiva software.

When to optimize settings Before you record data for a sample, optimize the cytometer settings for the sample type and fluorochromes used.

Manual compensation Compensation setup automatically calculates compensation settings. If you choose to perform compensation manually, not all of the following instructions apply. For detailed instructions, see the *BD FACSDiva Software Reference Manual*.

First-time users If you are performing the procedures in this workflow for the first time, you should be familiar with BD FACSDiva software concepts: workspace components, cytometer and acquisition controls, and tools for data analysis.

For additional details, see the *BD FACSDiva Software Reference Manual*.

Before you begin Start the BD FACSCelesta flow cytometer and perform the setup and QC procedures. See [Cytometer setup \(page 31\)](#).

Workflow for optimizing settings Cytometer optimization consists of the following steps.

Step	Description
1	Verifying the configuration and user preferences (page 64)
2	Running a performance check (page 67)
3	Setting up an experiment (page 72)

Step	Description
4	Creating application settings (page 77)
5	Recording compensation controls (page 80)
6	Calculating compensation (page 83)

Note: Application settings are optional and do not have to be saved for the experiments. However, they are useful for optimizing cytometer settings.

About the examples

The examples in this chapter use a 4-color bead sample with the following fluorochromes:

- FITC
- PE
- PerCP-Cy™5.5
- APC

If you follow this workflow with a different bead sample (or another sample type), your software views, data plots, and statistics might differ from the example. Additionally, you might need to modify some of the instructions in the procedure.

The information shown in italics is for example only. You can substitute your own names for folders and experiments.

Verifying the configuration and user preferences

Introduction

This topic describes how to verify the cytometer configuration and user preferences before you create an experiment.



Caution! To obtain accurate data results, the current cytometer configuration must reflect your BD FACSCelesta flow cytometer optics.

Procedure

To verify the configuration and preferences before you create an experiment:

1. Select **Cytometer > View Configurations** and verify the current configuration.

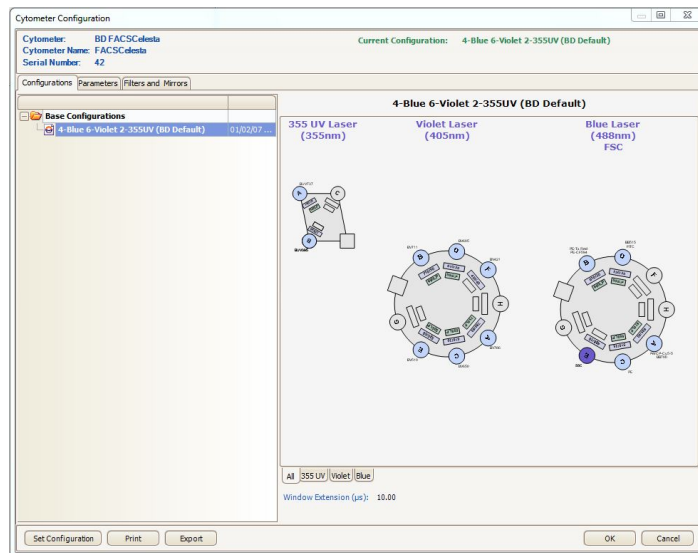

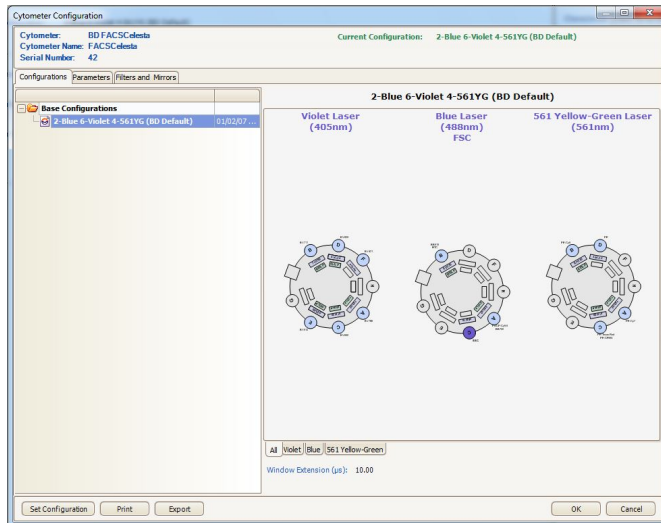
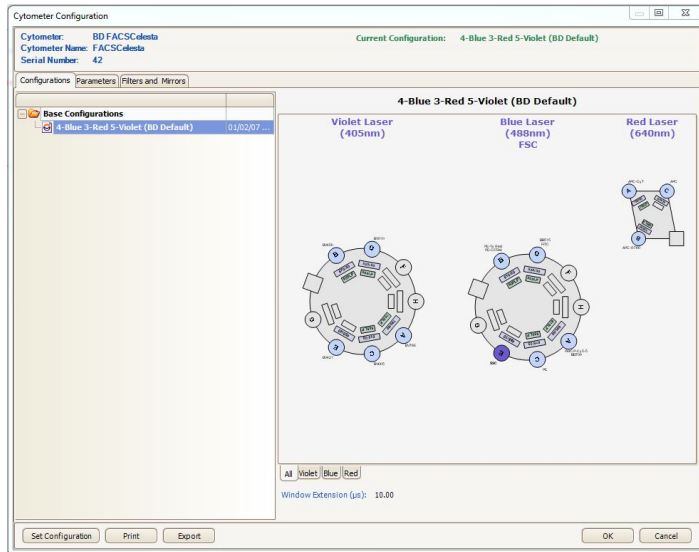

Your cytometer might include only the base configuration when your cytometer is installed. You can create additional configurations later as needed.

In this example, the cytometer configuration must include the following parameters: FITC, PE, PerCP-Cy5.5, and APC.

2. If you need to select a configuration other than the current configuration:
 - a. In the **Configurations** tab, select a configuration.
 - b. Click **Set Configuration**.
 - c. Click **OK**.
 - d. Verify that the configuration you just set matches your BD FACSCelesta flow cytometer optics.
3. Click **OK** to close the **Cytometer Configuration** window.
4. Select **File > Exit** to close CS&T.
5. Select **Edit > User Preferences**.
6. Click the **General** tab and select the **Load data after recording** checkbox.

See the *BD FACSDiva Software Reference Manual* for more information about cytometer configurations and user preferences.

Next step

[Running a performance check \(page 67\)](#)

More information

- [Setting up an experiment \(page 72\)](#)
-

Running a performance check

Introduction	This topic describes how to run a performance check as part of quality control.
Overview	<p>The CS&T application is designed to monitor performance on a daily basis and to optimize laser delay.</p> <p>Running a performance check on a regular basis provides a standard for monitoring changes in performance due to degradation of laser power, aging of PMTs, and other potential cytometer service issues. Performance results are also affected by fluidics performance. We strongly recommend following the fluidics maintenance procedures as described in Cleaning the fluidics (page 47).</p>
Considerations	Some BP filters might not be normalized to CS&T settings. In this case, CS&T will generate Qr and Br numbers that are not comparable from instrument to instrument. They are however, still trackable on one cytometer. Part of the process for optimizing cytometer settings includes verifying PMT voltages set by CS&T for all parameters. Carefully examine any channel with a non-CS&T normalized filter. If the baseline settings are not appropriate for your applications, adjust the PMT voltage as necessary and use the Application Settings to maintain Target Values.
Before you begin	Define the performance baseline for any configuration before running a performance check. See Custom configurations and baselines (page 43) .

Procedure

To run a performance check:

1. Select **Cytometer > CST**.
2. Verify that the bead lot information under **Setup Beads** matches the Cytometer Setup and Tracking bead lot.

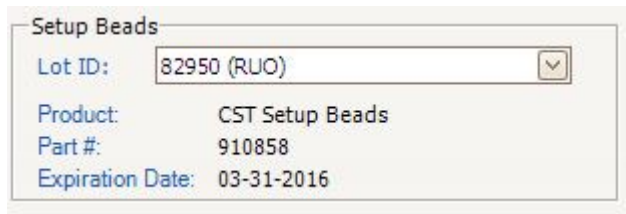

Setup Beads

Lot ID:	82950 (RUO)
Product:	CST Setup Beads
Part #:	910858
Expiration Date:	03-31-2016

3. Verify that the cytometer configuration is correct for your experiment.



System Summary: OK

Cytometer Configuration:	4-Blue 3-Red 5-Violet (BD Default)
Lot ID:	82950

If the cytometer is not set to the correct configuration:

- a. Click **Select Configuration** in the **Setup Control** window.
 - b. Select the correct configuration from the list.
 - c. Click **Set Configuration** and then click **OK**.
4. Verify that the current configuration has a valid baseline defined.

If not, see the *BD Cytometer Setup and Tracking Application Guide* for more information on defining a baseline.

5. Prepare the CS&T beads according to the technical data sheet provided with the beads or available on the BD Biosciences website (bdbiosciences.com).
6. Install the bead tube onto the SIP.

7. In the **Setup Control** window, select **Check Performance** from the **Characterize** menu.

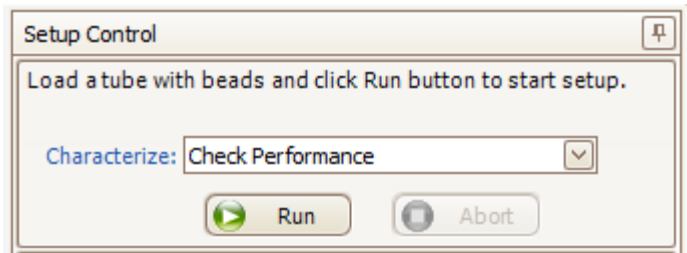

8. Click **Run**.
9. Ensure that Fine Adjust is set to 250, press RUN, and LOW.
Plots appear under the Setup tab and the performance check is run. The performance check takes approximately 5 minutes to complete.
10. Once the performance check is complete, click **View Report**.
11. Verify that the cytometer performance passed.
In the Setup tab, the cytometer performance results should have a green checkbox displayed and the word *Passed* next to it.

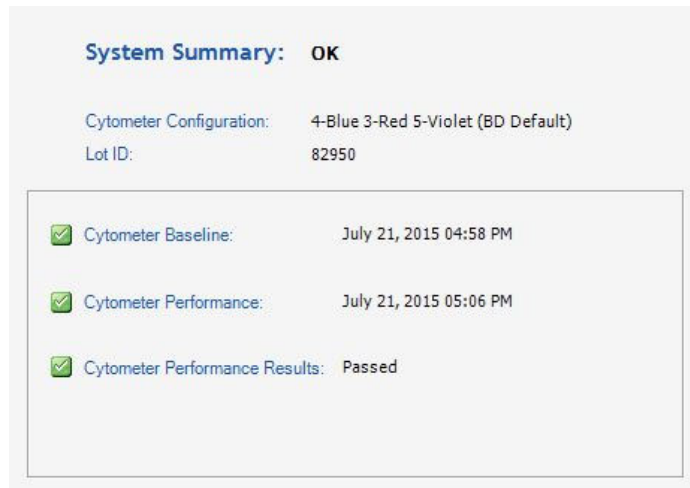

If any parameters did not pass, see the *BD Cytometer Setup and Tracking Application Guide* for troubleshooting information.

12. Select **File > Exit** to close the CS&T window and return to the BD FACSDiva interface.

The CST Mismatch dialog opens.

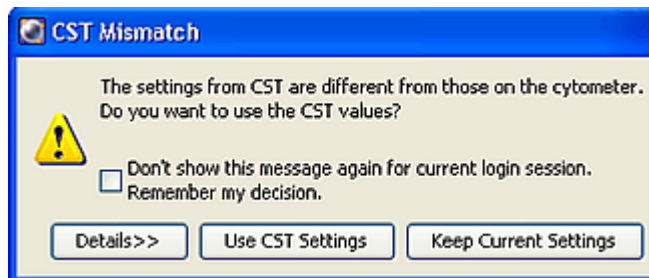

Click the **Details** button to verify which cytometer settings will be updated.

13. Click **Use CST Settings**.

By selecting Use CST Settings, the laser delay, area scaling, and other cytometer settings will be updated to the latest settings from the performance check.

Next step

Continue the optimization of your cytometer for an experiment or sample type as described in [Setting up an experiment \(page 72\)](#).

Setting up an experiment

Introduction

This topic describes how to create an experiment in a new folder, specify the parameters of the experiment, and add compensation tubes.

Creating an experiment

To create an experiment:

1. Click the buttons on the **Workspace** toolbar to display the following windows as needed:
 - Browser
 - Cytometer
 - Inspector
 - Worksheet
 - Acquisition Dashboard

When you add elements or make selections in the Browser, the Inspector displays details, properties, and options that correspond to your selection.

2. Click the **New Folder** button on the **Browser** toolbar to add a new folder.
3. Click the folder and rename it *MyFolder*.
4. Click *MyFolder*, then click the **New Experiment** button on the **Browser** toolbar.

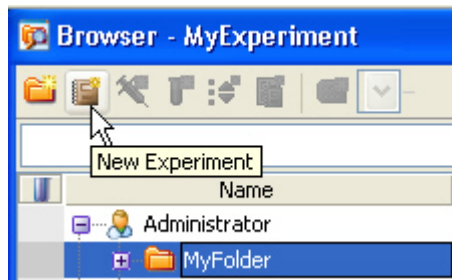

- a. Click the new experiment in the **Browser** and rename it *MyExperiment*.

5. Select *MyExperiment* in the **Browser**.

The Inspector displays details for the experiment.

Specifying parameters

To specify the parameters for the new experiment:

1. Select **Cytometer Settings** for the experiment in the **Browser**.

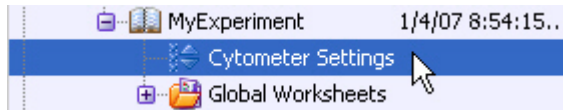

Cytometer settings appear in the **Inspector**.

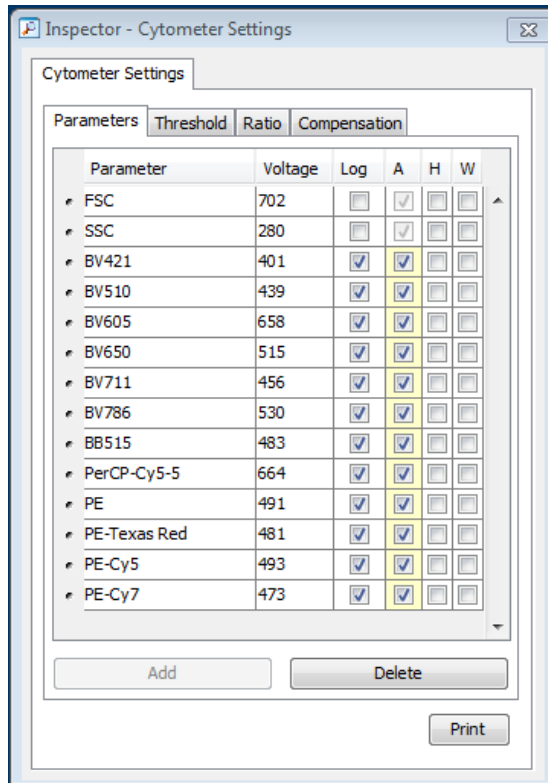

2. Make sure the parameters you need appear on the **Parameters** tab in the **Inspector**.

If more than one parameter is available for a particular detector, you might have to select the one you need from a menu. For example, you can set Detector D for the blue laser as FITC or BB515.

- a. Click the **Parameter** name to display the available fluorochromes in the **Parameters** list.

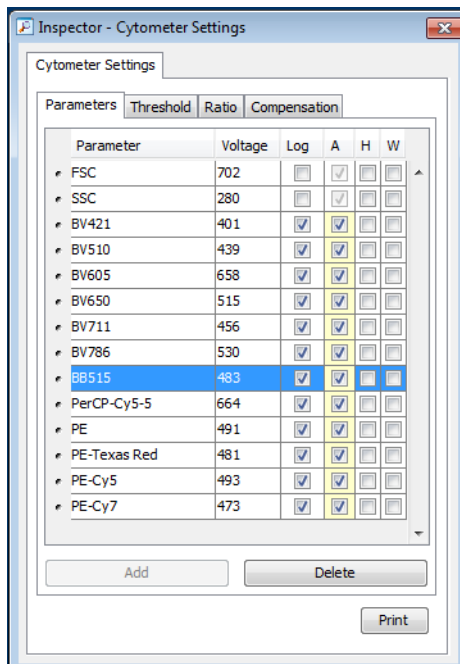

- b. Select the specific parameter from the menu. Your selection appears as the selected parameter.

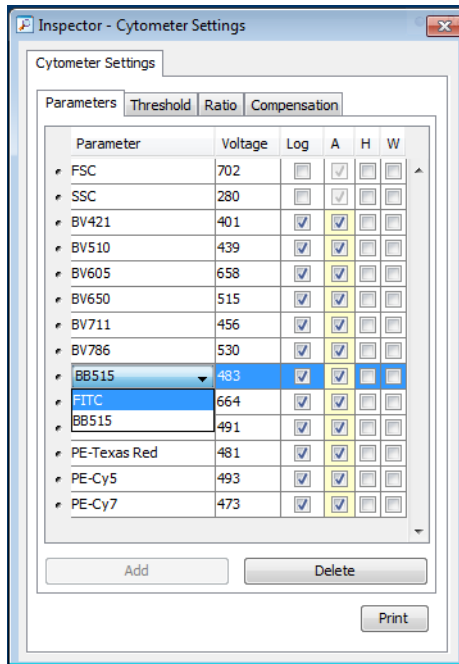

- c. For this example, select FITC from the menu.
3. Delete any unnecessary parameters.

- a. Click the selection button (to the left of the parameter name) to select the parameter.

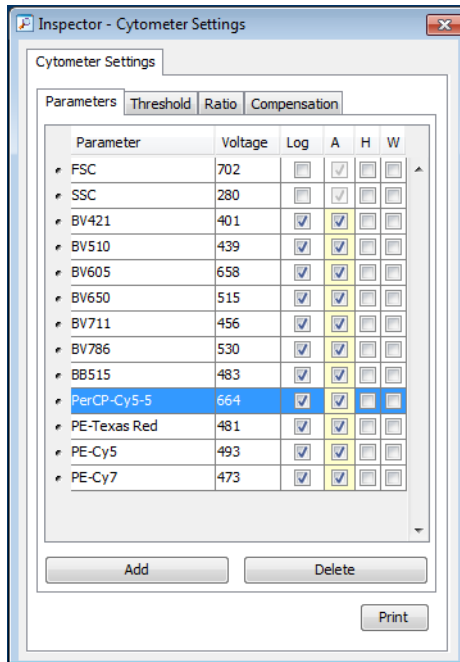

- b. Click **Delete**.
The parameter is deleted.
-

Creating application settings

Introduction

This topic describes how to create application settings.

About application settings

Application settings are associated with a cytometer configuration and include the parameters for the application, area scaling values, PMT voltages, and threshold values, but not compensation. Each time a performance check is run for a configuration, the application settings associated with that configuration are updated to the latest run.

Using application settings provides a consistent and reproducible way to reuse cytometer settings for commonly used applications.

Before you begin

Perform the cytometer setup procedure and run a performance check for the configuration that will be used for the application.

Procedure

To create application settings:

1. In the open experiment, right-click **Cytometer Settings** in the **Browser**, then select **Application Settings > Create Worksheet**.

A second global worksheet is added with the plots created according to the selections in the Parameters tab.

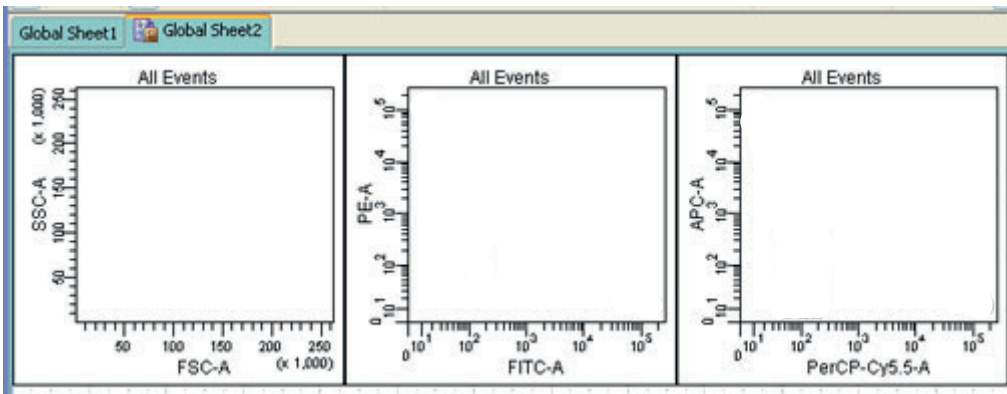

2. Load the unstained control tube onto the cytometer.

3. In the **Cytometer** window, optimize the PMT voltages for the application.
 - Optimize the FSC and SSC voltages to place the population of interest on scale.
 - Optimize the FSC threshold value to eliminate debris without interfering with the population of interest.
 - If needed, increase the fluorescence PMT voltages to place the negative population appropriately for your sample type.

Note: Do not decrease the fluorescence PMT voltages. Doing so can make it difficult to resolve dim populations from the negative population.
4. Unload the unstained control tube from the cytometer.
5. Load the multicolor sample onto the cytometer or load single-color control tubes and verify each fluorochrome signal separately.

6. Verify that the positive populations are on scale.
If a positive population is off scale, lower the PMT voltage for that parameter until the positive population can be seen entirely on scale.
7. Unload the multicolor sample.
8. Place a tube containing less than 1 mL DI water on the SIP and put the cytometer on standby.
9. (Optional) Save the application settings by right-clicking **Cytometer settings** in the **Browser**, then selecting **Application Settings > Save**.
10. In the **Save Application Settings** dialog, enter a descriptive name for the application settings.

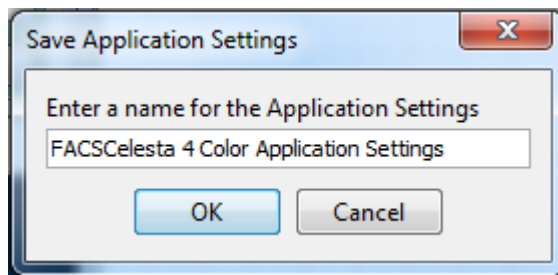

11. Click **OK**.

The application settings are saved to the catalog.

Next step

[Recording compensation controls \(page 80\)](#)

Recording compensation controls

Introduction

This topic describes how to create and record compensation controls using the Compensation Setup feature of BD FACSDiva software and an experiment with optimized settings.

Creating compensation tubes

To create compensation control tubes:

1. Select **Experiment > Compensation Setup > Create Compensation Controls**.

The Create Compensation Controls dialog opens.

For this bead example, you do not need to provide non-generic tube labels.

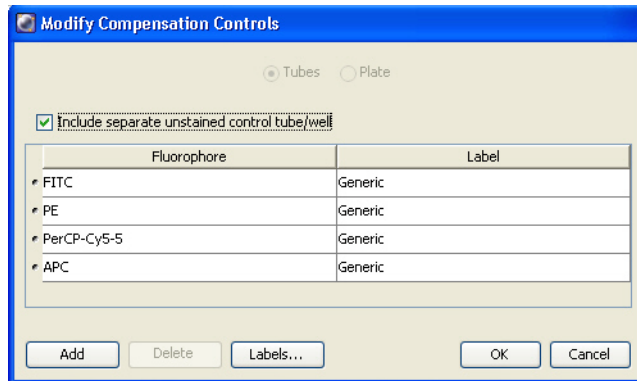

2. Click **OK**.

Compensation control tubes are added to the experiment. Worksheets containing appropriate plots and gates are added for each compensation tube.

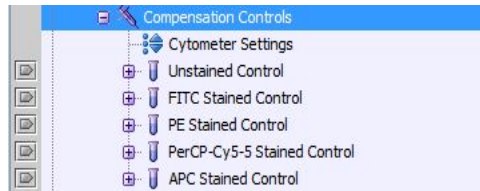

Recording compensation settings

To record compensation settings:

1. Press RUN and HIGH on the cytometer fluid control panel.
2. Install the unstained control tube onto the SIP.
3. Expand the **Compensation Controls** specimen in the **Browser**.
4. Set the current tube pointer to the unstained control tube (it becomes green), then click **Acquire Data** in the **Acquisition Dashboard**.
5. Verify that the population of interest is displayed appropriately on the FSC vs SSC plot and adjust voltages if necessary.

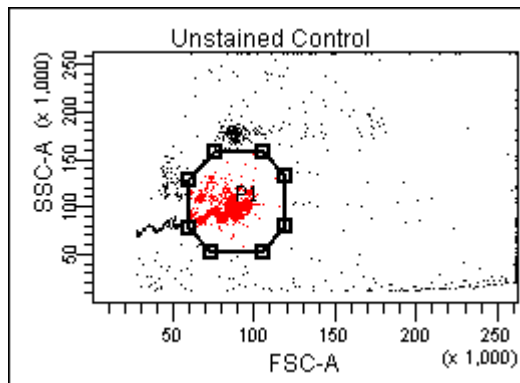

Since the application settings have been optimized for your sample, the cytometer settings should not require adjustment other than the changing of FSC and SSC voltages to place the beads on scale.

6. Adjust the P1 gate to surround only the singlets.
7. Right-click the P1 gate and select **Apply to All Compensation Controls**.

The P1 gate on each stained control worksheet is updated with your changes.

8. Click **Record Data**.
9. When recording is finished, remove the unstained control tube from the cytometer.
10. Click **Next Tube**.



Caution! Do not change the PMT voltages after the first compensation control has been recorded. In order to calculate compensation, all controls must be recorded with the same PMT voltage settings. If you need to adjust the PMT voltage for a subsequent compensation control, you must record all compensation controls again.

11. Install the next tube onto the cytometer and repeat steps 8 through 10 until data for all stained control tubes has been recorded.
12. Double-click the first stained control tube to display the corresponding worksheet.

13. Verify that the snap-to interval gate encompasses the positive population.

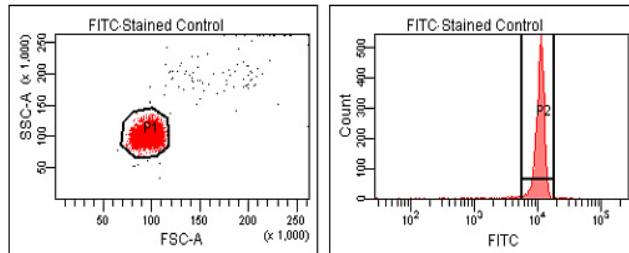

14. Repeat steps 12 and 13 for the remaining compensation tubes.

Next step

After you have recorded data for each single-stained control, calculate compensation as described in [Calculating compensation \(page 83\)](#).

Calculating compensation

Introduction

This topic describes how to calculate compensation.

Before you begin

Before you can calculate compensation, you need to record the data for each single-stained control.

Procedure

To calculate compensation:

1. Select **Experiment > Compensation Setup > Calculate Compensation**.

Note: If the calculation is successful, a dialog prompts you to enter a name for the compensation setup. The default name is year/month/day/time.

2. Enter a setup name and click **Link & Save**.

The compensation is linked to the cytometer settings and saved to the catalog.

To help track compensation setups, include the experiment name, date, or both in the setup name.

The compensation setup is linked to the *MyExperiment* cytometer settings, and subsequent acquisitions in *MyExperiment* are performed with the new compensation settings.

We recommend that you always visually and statistically inspect automatically calculated spectral overlap values. The medians of the positive controls should be aligned with the medians of the negative controls.

More information

- [Recording compensation controls \(page 80\)](#)
-

6

Recording and analyzing data

This chapter covers the following topics:

- [Data recording and analysis workflow \(page 86\)](#)
- [Preparing the workspace \(page 87\)](#)
- [Recording data \(page 88\)](#)
- [Analyzing data \(page 91\)](#)
- [Reusing an analysis \(page 97\)](#)

Data recording and analysis workflow

Introduction

This topic outlines the basic acquisition and analysis tasks using BD FACSDiva software.

About the examples

The examples in this chapter are from two 4-color bead samples with the following fluorochromes:

- FITC
- PE
- PerCP-Cy5.5
- APC

If you use a different sample type or if you have skipped the optimization steps in [Optimizing cytometer settings \(page 61\)](#), your software window content, names of folders and experiments, and your data plots and statistics might differ from those shown here. You might also need to modify some of the instructions in the procedure.

For additional details on completing some of the following steps, see the *BD FACSDiva Software Reference Manual*.

This procedure builds on the results obtained in [Optimizing cytometer settings \(page 61\)](#).

Workflow for recording and analyzing data

Recording and analyzing data consists of the following steps.

Step	Description
1	Preparing the workspace (page 87)
2	Recording data (page 88)
3	Analyzing data (page 91)
4	Reusing an analysis (page 97)

Preparing the workspace

Introduction

This topic describes how to prepare the workspace and apply application settings to your experiment before recording data.

Procedure

To prepare the workspace:

1. Using the **Browser** toolbar, create a new specimen in *MyExperiment* and rename it *FourColorBeads*.
 2. Create two tubes for the *FourColorBeads* specimen. Rename the tubes *Beads_001* and *Beads_002*.
 3. Expand the **Global Worksheets** folder in *MyExperiment* to access the default global worksheet, and rename the worksheet *MyData*.
 4. On the *MyData* worksheet, create the following plots for previewing the data:
 - FSC vs SSC
 - FITC vs PE
 - FITC vs PerCP-Cy5.5
 - FITC vs APC
-

Applying saved application settings to a new experiment

When application settings are applied to an experiment, the cytometer settings are updated with the parameters included in the application settings, optimized PMT voltages, threshold settings, area scaling factors, and window extension values.

To apply saved application settings to your experiment:

1. Right-click the experiment-level Cytometer Settings and select **Application Settings > Apply**.

2. In the **Application Settings** catalog, select the application settings file you saved previously and click **Apply**.

If the parameters are not the same, a mismatch dialog opens.

- Click **Overwrite** to update all settings.
- Click **Apply** to change only the common parameters.

For more information, see the *BD FACSDiva Software Reference Manual*.

The cytometer settings are renamed application settings and the cytometer settings icon in the Browser changes.

More information

- [Creating application settings \(page 77\)](#)
 - [Recording data \(page 88\)](#)
-

Recording data

Introduction

This topic provides an example of how to preview and record data for multiple samples.

Before you begin

Prepare the sample tubes.

Note: If you need to run samples at an event rate greater than 10,000 events/second, consider changing your Window extension. See the *BD FACSDiva Software Reference Manual* for more information.

Recording data

To record data:

1. Press RUN and HIGH on the cytometer fluid control panel.
2. Install the first sample tube onto the SIP.
3. Set the current tube pointer to *Beads_001*.

4. Click **Acquire Data** in the **Acquisition Dashboard** to begin acquisition.
5. While data is being acquired:
 - a. Draw a gate around the singlets on the FSC vs SSC plot.
 - b. Rename the P1 gate to *Singlets*.
 - c. Use the **Inspector** to set the other plots to show only the singlet population by selecting the Singlets checkbox.

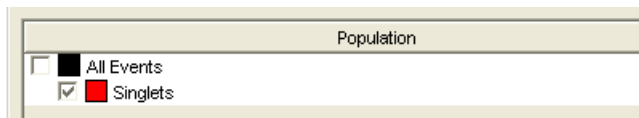

6. Click **Record Data**.
7. When event recording has completed, remove the first tube from the cytometer.

The *MyData* worksheet plots should look like the following.

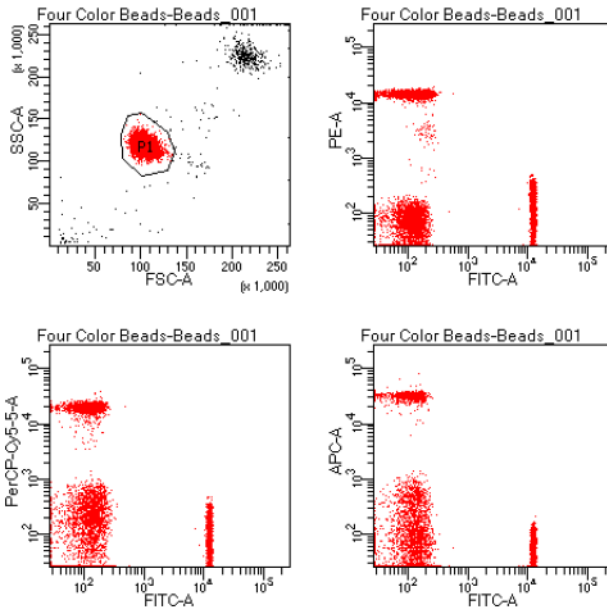

8. Install the second sample tube onto the SIP.
9. Set the current tube pointer to *Beads_002*.
10. Click **Acquire Data** to begin acquisition.
11. Before recording, preview the data on the *MyData* worksheet to verify that all expected populations are visible and the data is similar to the previous sample.
12. Click **Record Data**.
13. When event recording has completed, remove the second tube from the cytometer.
14. If you are recording more than two tubes, repeat steps 8 through 13 for the remaining tubes.
15. Print the experiment-level cytometer settings by right-clicking the **Cytometer Settings** icon in the **Browser** and selecting **Print**.

16. Install a tube with less than 1 mL of DI water onto the SIP.
17. Place the cytometer in standby mode.

More information

- [Analyzing data \(page 91\)](#)
-

Analyzing data

Introduction

This topic describes how to analyze recorded tubes by creating plots, gates, a population hierarchy, and statistics views on a new global worksheet.

Analyzing data
To analyze data:

1. Use the **Browser** toolbar to create a new global worksheet. Rename it *MyDataAnalysis*.
2. Create the following plots on the *MyDataAnalysis* worksheet:
 - FSC vs SSC
 - FITC vs PE
 - FITC vs PerCP-Cy5.5
 - FITC vs APC
3. Create a population hierarchy and a statistics view, and set them below the plots on the worksheet.
 - Right-click any plot and select **Show Population Hierarchy**.
 - Right-click any plot and select **Create Statistics View**.
4. Set the current tube pointer to *Beads_001*.
5. Draw a gate around the singlets on the FSC vs SSC plot.
6. Use the population hierarchy to rename the population *Singlets*.

7. Select all plots except the FSC vs SSC plot, and use the **Plot** tab in the **Inspector** to specify to show only the singlet population.

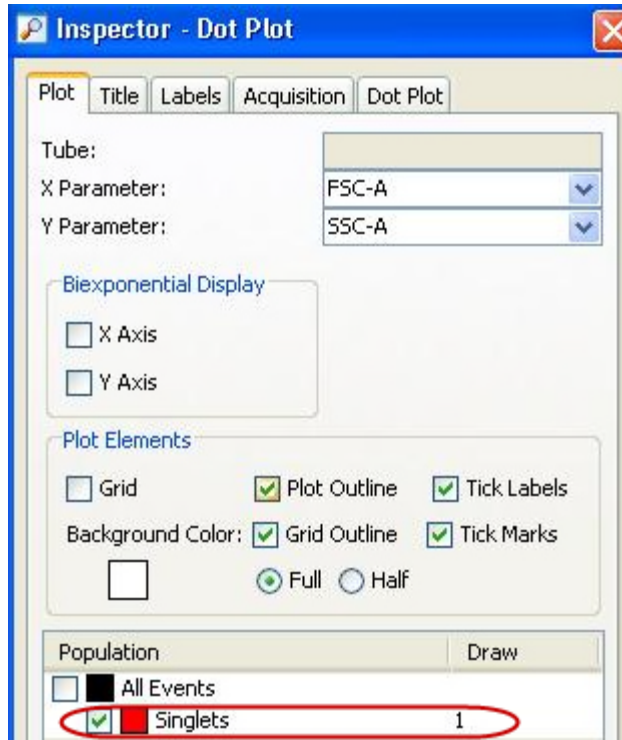

8. Select all plots, and click the **Title** tab in the **Inspector**.

9. Select the **Tube** and **Populations** checkboxes to display their names in plot titles.

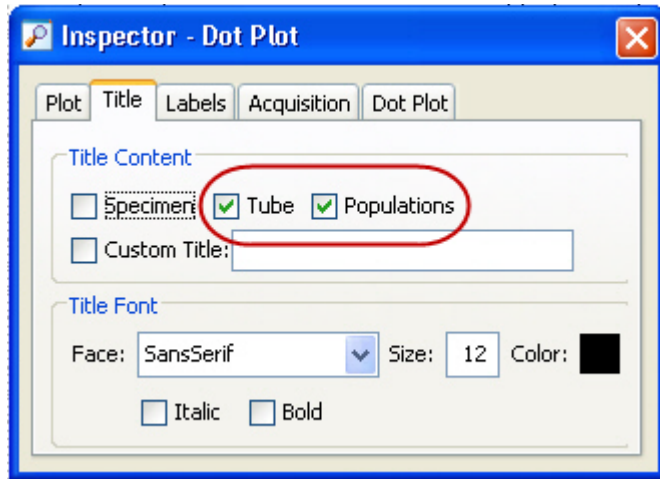

10. On all fluorescence plots:
 - Make all plots biexponential. Select all fluorescence plots and select the **X Axis** and **Y Axis** checkboxes in the **Plot** tab of the **Inspector**.

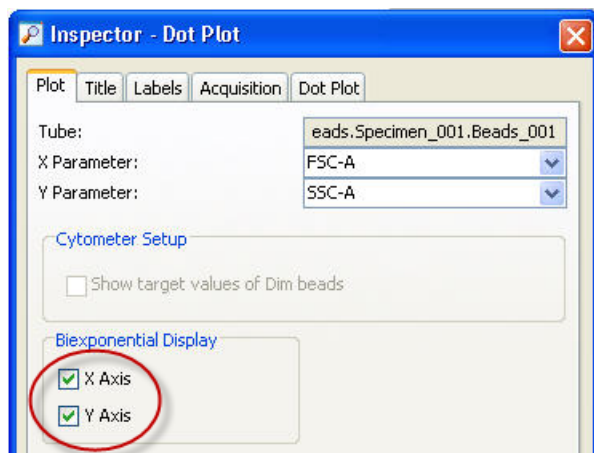

- In the FITC vs PE plot, draw a gate around the FITC-positive population. Name the population *FITC positive* in the population hierarchy.
- In the FITC vs PE plot, draw a gate around the PE-positive population. Name the population *PE positive* in the population hierarchy.
- In the FITC vs PerCP-Cy5.5 plot, draw a gate around the PerCP-Cy5.5-positive population. Name the population *PerCP-Cy5.5 positive* in the population hierarchy.
- In the FITC vs APC plot, draw a gate around the APC-positive population. Name the population *APC positive* in the population hierarchy.

11. Format the statistics view.

- a. Right-click the statistics view and select **Edit Statistics View**.
- b. Click the **Header** tab and select the **Specimen Name** and **Tube Name** checkboxes.
- c. Click the **Populations** tab and select all populations except **All Events**. Clear the **%Parent**, **%Total**, and **#Events** checkboxes.
- d. Click the **Statistics** tab and select the mean for each of the fluorescence parameters.

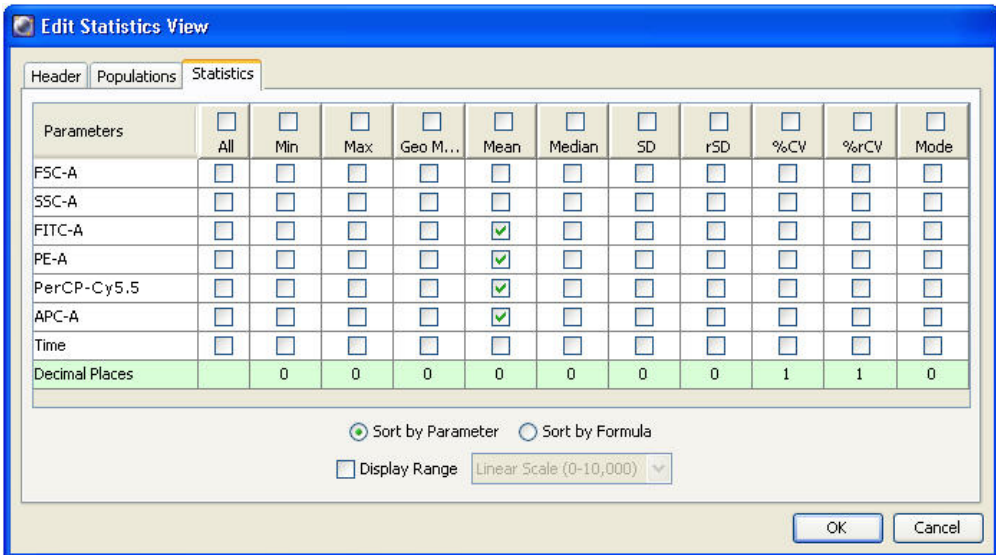

e. Click **OK**.

12. Print the analysis.

Your global worksheet analysis objects should look like the following.

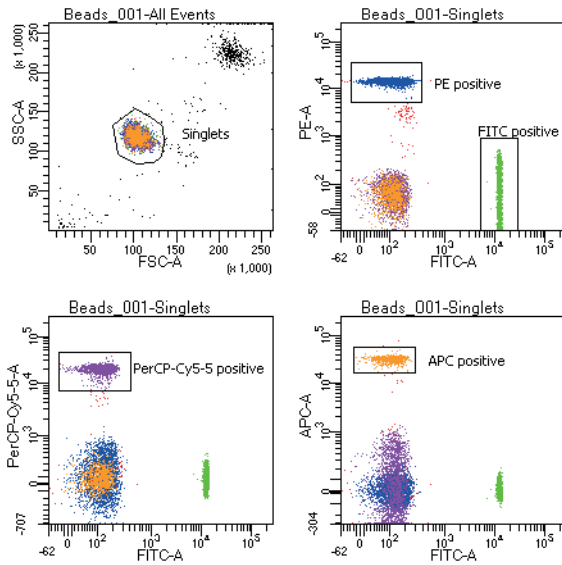

Tube: Beads_001

Population	#Events	%Parent	%Total
All Events	10,000	####	100.0
Singlets	9,412	94.1	94.1
FITC positive	3,795	40.3	38.0
PE positive	2,511	26.7	25.1
PerCP-Cy5-5 positive	2,085	22.2	20.8
APC positive	918	9.8	9.2

Specimen Name: Four Color Beads
Tube Name: Beads_001

Population	FITC-A Mean	PE-A Mean	PerCP-C... Mean	APC-A Mean
All Events	5,330	4,221	4,910	3,313
Singlets	5,016	3,952	4,593	3,195
FITC positive	12,244	86	63	20
PE positive	126	14,508	122	7
PerCP-Cy5-5 positive	118	68	20,354	22
APC positive	107	57	71	32,298

-
- More information**
- [Reusing an analysis \(page 97\)](#)
-

Reusing an analysis

Introduction This topic describes how to use a global worksheets to apply the same analysis to a series of recorded tubes. Once you define an analysis for a tube, you can use it to analyze the remaining tubes in the experiment. After viewing the data, print the analysis or save it to a normal worksheet.

Reusing an analysis **To reuse the analysis:**

1. Set the current tube pointer to the *Beads_002* tube.
2. View the *Beads_002* data on your analysis worksheet. Adjust the gates as needed.

Adjustments apply to subsequent tubes viewed on the worksheet. To avoid altering a global worksheet, save an analysis to a normal worksheet, then make adjustments on the normal worksheet.
3. Print the analysis.

Saving the analysis When you perform analysis with a global worksheet, the analysis does not save with the tube.

If you define your analysis on a global worksheet before recording data, you can specify to automatically save the analysis after recording data. You set this option in User Preferences.

To save a copy of the analysis with a tube:

1. Expand the *MyDataAnalysis* global worksheet icon in the **Browser**.

2. Right-click its analysis and select **Copy**.



3. Click the **Worksheets View** button on the **Worksheet** toolbar to switch to the normal worksheet view.
4. Select **Worksheet > New Worksheet** to create a new normal worksheet.
5. Right-click the *Beads_001* tube icon in the **Browser**, and select **Paste**.

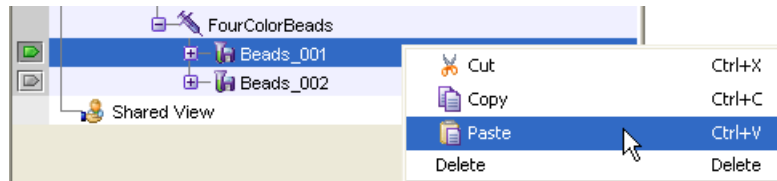

The analysis objects from the *MyDataAnalysis* global worksheet are copied to the *Beads_001_Analysis* normal worksheet. Double-click the *Beads_001* tube in the Browser to view the analysis.

Applying an analysis to normal worksheets

You can apply the global worksheet analysis to multiple tubes (on a single normal worksheet) by selecting multiple tubes before pasting the analysis. Ensure that you collapse all tube elements in the Browser before you paste them to multiple tubes.

More information

- [Analyzing data \(page 91\)](#)
-

7

Technical overview

This chapter provides a technical overview of the following topics:

- [About fluidics \(page 100\)](#)
- [About optics \(page 101\)](#)
- [About electronics \(page 112\)](#)

About fluidics

Introduction

This topic describes the BD FACSCelesta flow cytometer fluidics system.

Pressure-driven fluidics system

The fluidics system in the BD FACSCelesta flow cytometer operates at a pressure of 5.5 psi. After passing through the sheath filter, sheath fluid is introduced into the lower chamber of the quartz flow cell.

Hydrodynamic focusing

The sample to be analyzed arrives in a separate pressurized stream. When a sample tube is placed on the SIP, the sample is forced up and injected into the lower chamber of the flow cell by a slight overpressure relative to the sheath fluid. The conical shape of the lower chamber creates a laminar sheath flow that carries the sample core upward through the center of the flow cell, where the particles to be measured are intercepted by the laser beam. This process is known as hydrodynamic focusing.

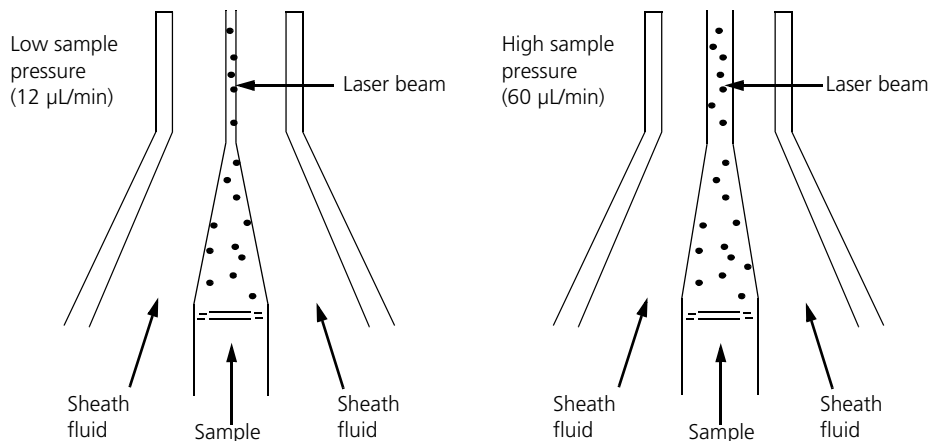

The objective in flow cytometric analysis is to have at most one cell or particle moving through a laser beam at a given time. The difference in pressure between the sample stream and sheath fluid stream can be used to vary the diameter of the sample core.

Changing the sample flow rate changes the sample pressure thereby changing the core diameter. The flow rate should be set according to the type of application you are running.

- A higher flow rate is generally used for qualitative measurements such as immunophenotyping. The data is less resolved, but is acquired more quickly.
- A lower flow rate is generally used in applications where greater resolution and quantitative measurements are critical, such as DNA analysis.

Proper operation of fluidic components is critical for particles to intercept the laser beam properly. Always ensure that the fluidics system is free of air bubbles and debris, and is properly pressurized.

About optics

Introduction

This topic describes the optics system and provides information about:

- [Light scatter \(page 102\)](#)
 - [Fluorescence \(page 102\)](#)
 - [Optical filter theory \(page 104\)](#)
 - [Compensation theory \(page 109\)](#)
-

Optics system

The optics system consists of lasers, optical filters, and detectors. Lasers illuminate the cells or particles in the sample and optical filters direct the resulting light scatter and fluorescence signals to the appropriate detectors.

Light scatter

When a cell or particle passes through a focused laser beam, laser light is scattered in all directions. Light that scatters axial to the laser beam is called forward scatter (FSC) and light that scatters perpendicular to the laser beam is called side scatter (SSC).

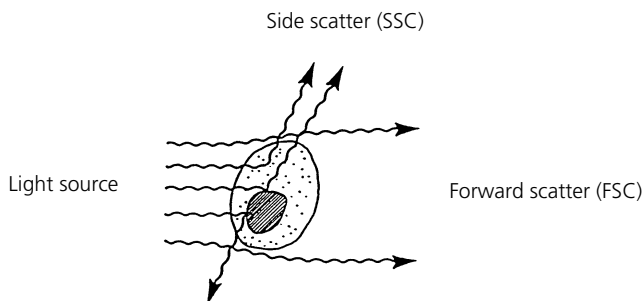

FSC and SSC are related to certain physical properties of cells.

- **FSC.** Indicates relative differences in the size of the cells or particles. Larger cells scatter more light and therefore they are higher in FSC.
- **SSC.** Indicates relative differences in the internal complexity or granularity of the cells or particles. More granular cells deflect more light than less granular cells, and therefore are higher in SSC.

Fluorescence

When cells or particles stained with fluorochrome-conjugated antibodies or other dyes pass through a laser beam, the dyes can absorb photons (energy) and be promoted to an excited electronic state. In returning to their ground state, the dyes release energy, most of which is emitted as light. This light emission is known as fluorescence.

Fluorescence is always a longer wavelength (lower-energy photon) than the excitation wavelength. The difference between the excitation wavelength and the emission wavelength is known as the Stokes shift. Some fluorescent compounds such as PerCP exhibit a large Stokes shift, absorbing blue light (488 nm) and emitting red light (675 nm), while other fluorochromes such as

FITC have a smaller Stokes shift, absorbing blue light (488 nm) and emitting green light (530 nm).

The following figure shows the emission spectra of some commonly used fluorochromes.

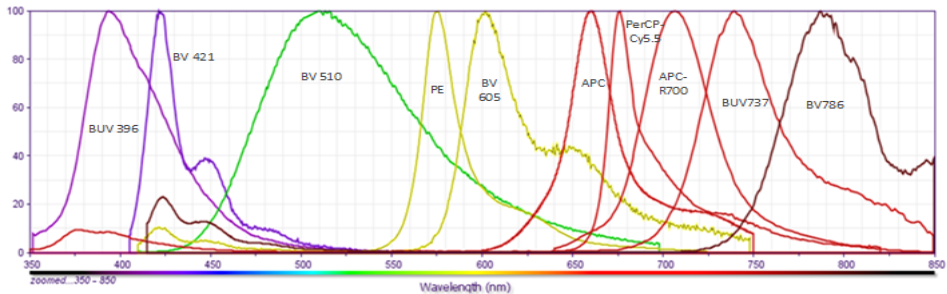

Actual emission intensity will depend on excitation wavelength. See [Fluorescence spectra \(page 128\)](#) for more information on excitation and emission of fluorochromes. An interactive spectral viewer is also available at bdbiosciences.com.

Optical filter theory Optical filters modify the spectral distribution of light scatter and fluorescence directed to the detectors. When photons encounter an optical filter, they are either transmitted, absorbed, or reflected.

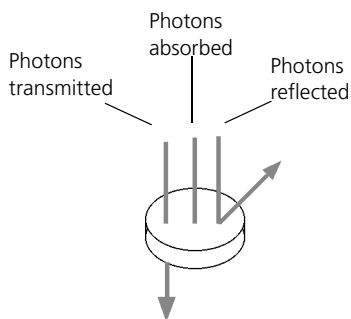

Even though an optical filter is rated at its 50% transmission point, the filter passes (lets through) a minimal amount of light outside of this indicated rating.

The slope of an optical filter transmission curve indicates filter performance. A relatively steep slope indicates a high-performance, high-quality optical filter that provides deep attenuation of out-of-band wavelengths. A less steep slope indicates that more light outside the rated bandwidth is being transmitted.

Types of optical filters

There are four types of filters.

- **Longpass (LP) filters.** Transmit wavelengths at or longer than the specified value.
- **Shortpass (SP) filters.** Transmit wavelengths at or shorter than the specified value. This type of filter is not recommended.
- **Bandpass (BP) filters.** Pass a narrow spectral band of light by combining the characteristics of shortpass filters, longpass filters, and absorbing layers.
- **Notch filters.** Pass all frequencies except those in a stop band centered on a center frequency. They are the opposite of bandpass filters.

The BD FACSCelesta uses LP filters and BP filters.

Longpass (LP) filters

LP filters pass wavelengths longer than the filter rating. For example, a 500-LP filter permits wavelengths 500 nm or longer to pass through it and either absorbs or reflects wavelengths shorter than 500 nm.

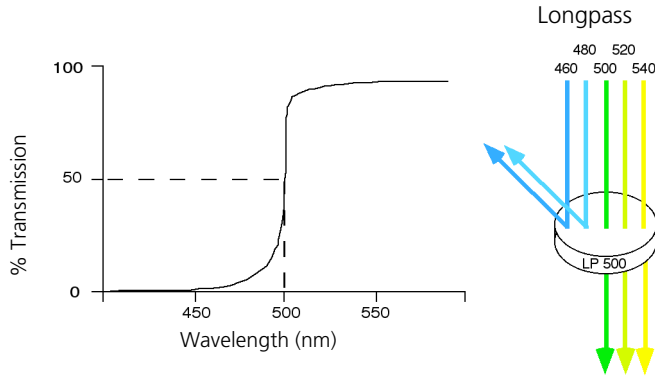

**Shortpass (SP)
filters**

An SP filter has the opposite properties of an LP filter. An SP filter passes light with a shorter wavelength than the filter rating. For example, a 500-SP filter passes wavelengths of 500 nm or shorter, and reflects or absorbs wavelengths longer than 500 nm.

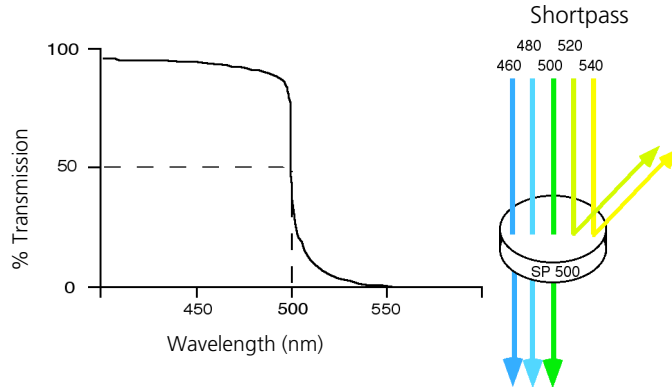

Bandpass (BP) filters

A BP filter transmits a relatively narrow range or band of light. BP filters are typically designated by two numbers. The first number indicates the center wavelength and the second refers to the width of the band of light that is passed. For example, a 500/50-BP filter transmits light that is centered at 500 nm and has a total bandwidth of 50 nm. Therefore, this filter transmits light between 475 and 525 nm.

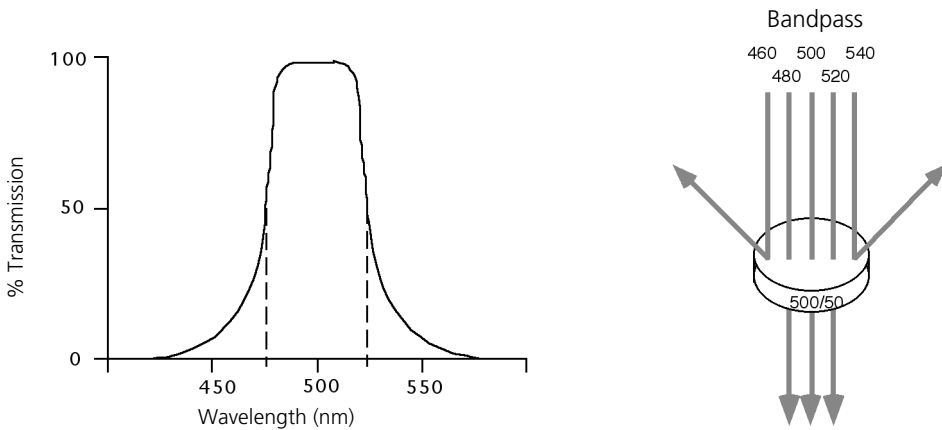

The performance of an optical BP filter depends on the optical transmission. Sample transmission curves are shown in the following figure. A filter with a narrower (steeper) transmission curve generally yields higher performance. The transmission specifications depend on the construction of the filter.

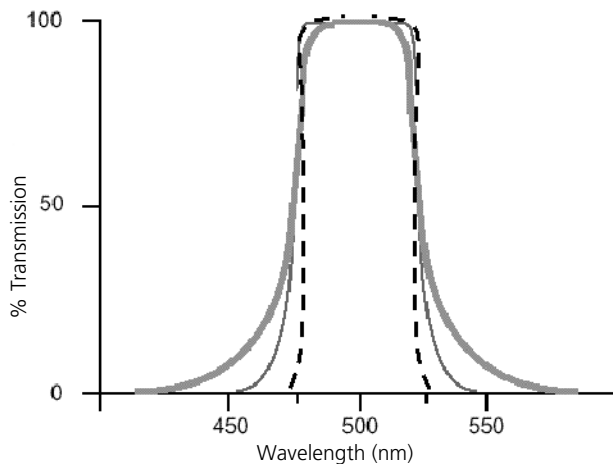

Dichroic mirrors

Dichroic filters that are used to direct different color light signals to different detectors are called dichroic mirrors.

Although some of the properties of LP and SP filters are similar to dichroic mirrors (for example, allowing a specific wavelength range to pass), filters and mirrors cannot be used interchangeably, especially if used as dichroic mirrors. A dichroic mirror must have a surface coating that reflects certain wavelengths, but many LP or SP filters are absorbance filters that do not have any specific reflective characteristics. Also, optical filters and dichroic mirrors are rated at a specific angle of incidence. When used in front of the fluorescence detectors, they are perpendicular to the incident light, and when used as a dichroic mirror, they are placed at an angle relative to the light source. Their optical properties are therefore designed for that angle of incidence.

Compensation theory

Fluorochromes emit light over a range of wavelengths. Optical filters are used to limit the range of frequencies measured by a given detector. However, when two or more fluorochromes are used, the overlap in wavelength ranges often makes it impossible for optical filters to isolate light from a given fluorochrome. As a result, light emitted from one fluorochrome appears in a detector intended for another. This is referred to as spillover. Spillover can be corrected mathematically by using a method called compensation.

In the following example, FITC emission appears primarily in the FITC detector, but some of its fluorescence spills over into the PE detector. The spillover must be corrected or compensated for. Alternatively, the spillover can be minimized by discrete excitation of fluorochromes. In the following example, excitation with a yellow-green configuration will help minimize spillover.

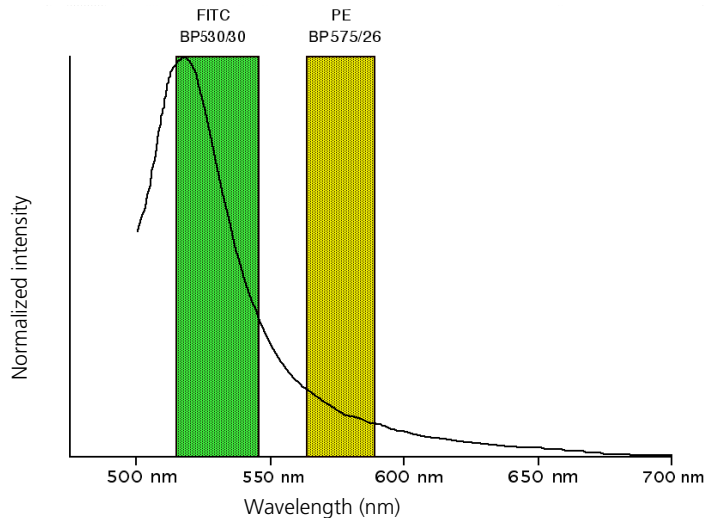

This spillover can be seen in a dot plot of FITC vs PE. The FITC spillover in the PE detector must be corrected as demonstrated in the two figures that follow.

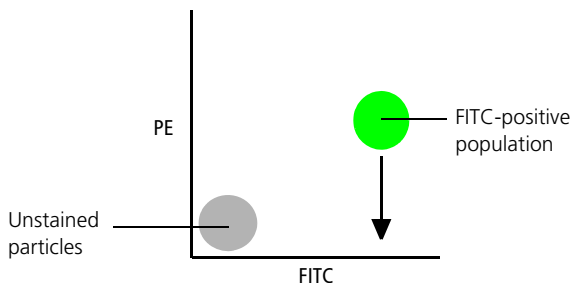

Using the Compensation tab of the Cytometer window in BD FACSDiva software, you can adjust the PE-%FITC spectral overlap value. Compensation is optimal when the positive and negative FITC populations have the same medians in the PE parameter statistics.

The following image shows the FITC spillover optimally compensated out of the PE parameter.

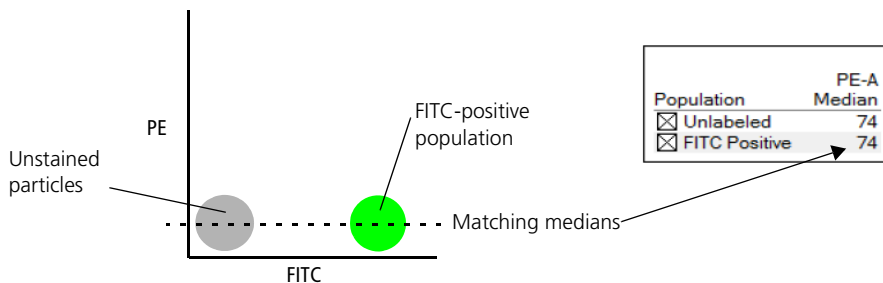

Once fluorescence compensation has been set for any sample, the compensation setting remains valid for a subsequent dim or bright sample (provided the signal is not saturated), because compensation subtracts a percentage of the fluorescence intensity. The following figure illustrates this principle. Although the signals differ in intensity, the percentage of the FITC spillover into the PE detector remains constant.

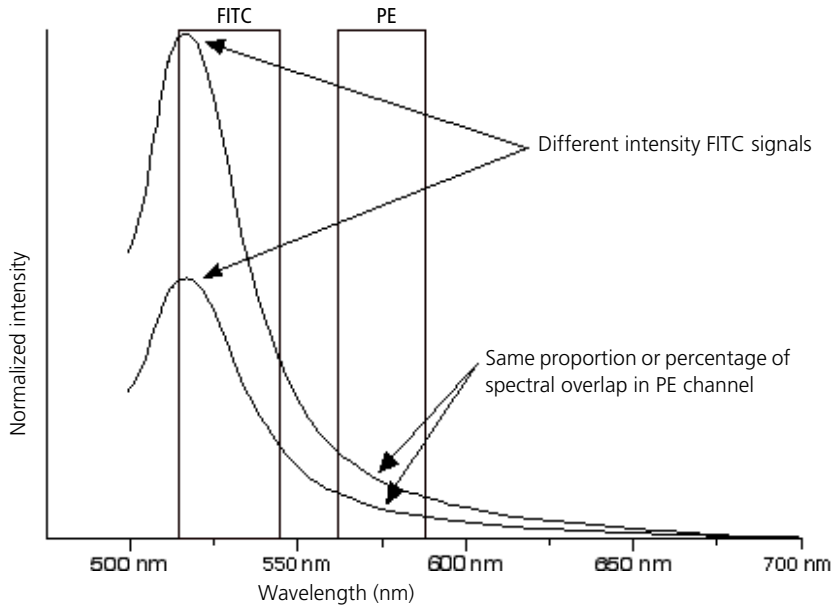

About electronics

Introduction

This topic describes the electronics in the BD FACSCelesta flow cytometer

Pulse

As cells or other particles pass through a focused laser beam, they scatter the laser light and can emit fluorescence. Because the laser beam is focused on a small spot and particles move rapidly through the flow cell, the scatter or fluorescence emission signal has a very brief duration—only a few microseconds. This brief flash of light is converted into an electrical signal by the detectors. The electrical signal is called a pulse. The following figures illustrate the anatomy of a pulse.

1. A pulse begins when a particle enters the laser beam. At this point, both the beam intensity and signal intensity are low.

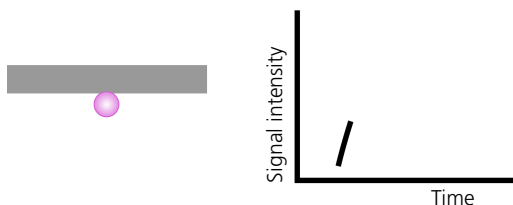

2. The pulse reaches a maximum intensity or height when the particle reaches the middle of the beam, where the beam and signal intensity are the brightest. The peak intensity, or height of the pulse, is measured at this point.

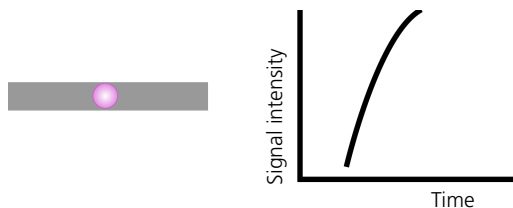

- As the particle leaves the beam, the pulse trails off below the threshold.

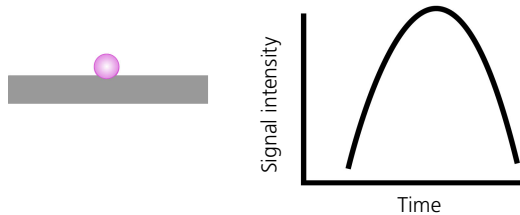

Pulse measurements

The pulse processors measure pulses by three characteristics: height, area, and width.

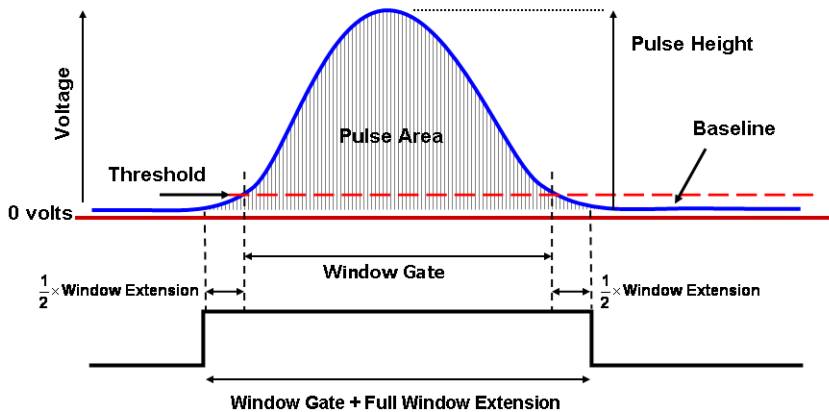

- **Height.** The maximum digitized intensity measured for the pulse.
- **Area.** The integration of all the digitized samples over time, where time is the window gate plus $\frac{1}{2}$ the window extension added before the initial threshold, plus the other half of the window extension value added after the pulse drops below the threshold. The window gate extends until the pulse is 75% of the initial threshold.
- **Width.** The current width is measured by the electronics.

Digital electronics BD FACSCelesta electronics digitize the signal intensity produced by a detector. The digitized data is stored in memory and further processed by the electronics to calculate:

- Pulse height and area
- Compensation
- Parameter ratios

These results are transferred to your workstation computer for further processing by BD FACSDiva software. For more information about digital theory, see Digital Theory in the *BD FACSDiva Software Reference Manual*.

Threshold

The threshold is the level at which the system starts to measure signal pulses. A threshold is defined for a specific detector signal. The system continuously samples the digitized signal data and calculates pulse area and height for all channels based on the time interval during which the threshold is exceeded.

Thresholds can also be set for more than one parameter, and pulse measures are based on either of the following:

- Intervals during which ALL signals exceed their threshold value (AND threshold in the software)
- Intervals during which ANY signal exceeds its threshold value (OR threshold in the software)

Laser controls

Controls in the Laser tab of the Cytometer window are used to manually set the (laser) delay, area scaling, and window extension values.

These parameters are set by BD Biosciences service personnel during instrument installation and performance check and are updated each time you run a performance check.

Note: Do not otherwise change the settings in the Laser tab unless instructed to do so by BD Biosciences. Changing the settings affects your data.

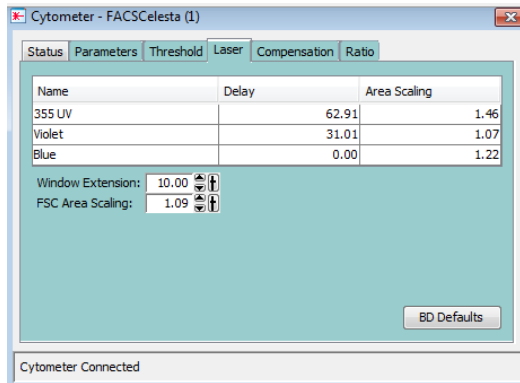

More information

- [Running a performance check \(page 67\)](#)

This page intentionally left blank

8

Troubleshooting

This chapter covers the following topics:

- [Cytometer troubleshooting \(page 118\)](#)
- [Electronics troubleshooting \(page 126\)](#)

Cytometer troubleshooting

Introduction

This topic describes possible problems and recommended solutions for BD FACSCelesta flow cytometer issues.

Droplets are visible on the SIP

Possible causes	Recommended solutions
Worn O-ring in the retainer	Replace the O-ring. See Changing the sample tube O-ring (page 58) .
Outer sleeve is not seated in the retainer	<ol style="list-style-type: none"> Loosen the retainer. Push the outer sleeve up into the retainer until seated. Tighten the retainer.
Outer sleeve is not on the sample injection tube	<p>Replace the outer sleeve.</p> <ol style="list-style-type: none"> Loosen the retainer. Slide the outer sleeve over the sample injection tube until it is seated. Tighten the retainer.
Waste line is pinched, preventing proper aspiration	Check the waste line.
Waste tank is full	Empty the waste tank.
Droplet containment vacuum is not functioning	Call your BD service representative.
The mode is not set to HTS.	Change the mode to HTS by pressing down the MODE button for more than 3 seconds.

Sample tube not fitting on SIP

Possible causes	Recommended solutions
Sample tube other than Falcon® tubes used	Use Falcon 12 x 75-mm polystyrene sample tubes. See Equipment (page 146) .
Worn Bal seal	Replace the Bal seal. See Changing the Bal seal (page 56) .
Sample tube is cracked	Transfer contents to a new tube.

Rapid sample aspiration

Possible causes	Recommended solutions
Support arm is to the side	Place the support arm under the sample tube.
Droplet containment module is failing	Try the solutions in Droplets are visible on the SIP (page 118) . If the issue is not resolved, call your BD service representative.

No events in acquisition display and RUN button is green

Possible causes	Recommended solutions
Threshold is not set to the correct parameter (usually FSC)	Set the threshold to the correct parameter for your application.
Threshold level is too high	Lower the threshold level.
PMT voltage for threshold parameter is set too low	Set the PMT voltage higher for the threshold parameter.
Gating issue	See the <i>BD FACSDiva Software Reference Manual</i> for information on setting gates.
Air in the sheath filter	Purge the filter. See Removing air bubbles (page 35) .

Possible causes	Recommended solutions
Air bubble or debris in the flow cell	Prime the fluidics system. See Priming the fluidics (page 40) .
No sample in the tube	Verify that sample remains in the tube and if necessary, add sample to the tube or install a new sample tube.
Sample is not mixed properly	Mix the sample to suspend the cells.
Waste tank is full	Empty the waste tank.
PMT voltages set too low or too high for display parameter	Adjust the PMT voltages.
Too few events are displayed	Increase the number of events to display.
Sample injection tube is clogged	Remove the sample tube to allow backflushing. If the event rate is still erratic, clean the sample injection tube. See Cleaning the fluidics (page 47) .
Bal seal is worn	Replace the Bal seal. See Changing the Bal seal (page 56) .
Instrument is not warmed up	Wait 30 minutes for the instrument to warm up.
Laser is not functioning	Verify the malfunction by changing the threshold to an alternative laser while running the appropriate sample. If unsuccessful, contact BD Biosciences.
Tube is cracked or misshapen	Replace the sample tube. Waste tank is pressurized. Disconnect the waste container for at least 30 seconds to allow the pressure to dissipate.

No events in acquisition display and RUN button is orange

Possible causes	Recommended solutions
RUN is not activated	Press the RUN button.
Sample tube is not installed or is not properly seated	Install the sample tube correctly on the SIP.
Sample tube is cracked	Replace the sample tube.
Waste tubing line is disconnected from the waste container tank	Connect the waste tubing line to the waste container tank.
Sheath container is not pressurized	<ul style="list-style-type: none"> • Ensure that the sheath container lid and all connectors are securely seated. • Inspect the sheath container O-ring inside the lid and replace it if necessary. See Cleaning or replacing the sheath gasket (page 60)
Bal seal is worn	Replace the Bal seal. See Changing the Bal seal (page 56) .
Air leak at sheath container	Ensure that the sheath container lid and all connectors are securely seated.
Sheath container is empty	Fill the sheath container.
Air in sheath filter	Purge the filter. See Removing air bubbles (page 35) .

No fluorescence signal

Possible causes	Recommended solutions
Incorrect fluorochrome assignment	Make sure that the cytometer configuration in the software matches the optical filters in the cytometer and the configuration is as expected.
Laser is not functioning	Call your BD service representative.

No signal in red laser channels (when red laser is installed)

Possible causes	Recommended solutions
Incorrect laser delays due to a change in the sheath tank fluid level	<ul style="list-style-type: none"> Check the fluid level in the sheath tank and refill if necessary.

High event rate

Possible causes	Recommended solutions
Air bubbles in the sheath filter or flow cell	Remove the air bubbles. See Removing air bubbles (page 35) .
Threshold level is too low	Increase the threshold level. See the <i>BD FACSDiva Software Reference Manual</i> for instructions.
PMT voltage for the threshold parameter is set too high	Set the PMT voltage lower for the threshold parameter. See the <i>BD FACSDiva Software Reference Manual</i> for instructions.
Sample is too concentrated	Dilute the sample.
Sample flow rate is set to HIGH	Set the sample flow rate to MED or LOW.

Low event rate

Possible causes	Recommended solutions
Threshold level is too high	Lower the threshold level. See the <i>BD FACSDiva Software Reference Manual</i> for instructions.
Air bubble or debris in the flow cell	Prime the fluidics system. See Priming the fluidics (page 40) .
PMT voltage for the threshold parameter is set too low	Set the PMT voltage higher for the threshold parameter. See the <i>BD FACSDiva Software Reference Manual</i> for instructions.

Possible causes	Recommended solutions
Sample is not adequately mixed	Mix the sample to suspend the cells.
Sample is too diluted	Concentrate the sample. If the flow rate setting is not critical to the application, set the flow rate switch to MED or HIGH.
Sample injection tube is clogged	Remove the sample tube to allow backflushing. If the event rate is still erratic, clean the sample injection tube. See Cleaning the fluidics (page 47) .

Erratic event rate

Possible causes	Recommended solutions
Sample tube is cracked	Replace the sample tube.
Air bubble or debris in the flow cell	Prime the fluidics system. See Priming the fluidics (page 40) .
Bal seal is worn	Replace the Bal seal. See Changing the Bal seal (page 56) .
Sample injection tube is clogged	Remove the sample tube to allow backflushing. If the event rate is still erratic, clean the sample injection tube. See Cleaning the fluidics (page 47) .
Contaminated sample	Prepare the specimen again. Ensure that the tube is clean.
Sheath filter is dirty	Replace the filter. See Changing the sheath filter (page 54) .

Distorted scatter parameters

Possible causes	Recommended solutions
Cytometer settings are improperly adjusted	Optimize the scatter parameters. See the <i>BD FACSDiva Software Reference Manual</i> for instructions.
Air bubble in the sheath filter or flow cell	Purge the air from the filter. See Removing air bubbles (page 35) .
Flow cell is dirty	Flush the system. See Flushing the system (page 50) .
Air leak at sheath container	Ensure that the sheath container lid is tight and all connectors are secure.
Hypertonic buffers or fixative	Replace the buffers or fixative.

Excessive amount of debris in display

Possible causes	Recommended solutions
Threshold level is too low	Increase the threshold level.
Sheath filter is dirty	Replace the filter. See Changing the sheath filter (page 54) .
Flow cell is dirty	Flush the system. See Flushing the system (page 50) .
Dead cells or debris in the sample	Examine the sample under a microscope.
Sample is contaminated	Re-stain the sample. Ensure that the tube is clean.
Stock sheath fluid is contaminated	Rinse the sheath container with DI water, then fill the container with sheath fluid from another (or new lot) bulk container.

High CV or poor QC results

Possible causes	Recommended solutions
Air bubble in sheath filter or flow cell	<ul style="list-style-type: none"> • Purge the filter. See Removing air bubbles (page 35). • Prime the fluidics system. See Priming the fluidics (page 40).
Sample flow rate is set too high	Set the sample flow rate lower.
Air leak at sheath container	Ensure that the sheath container lid is tight and all connectors are secure.
Flow cell is dirty	Flush the system. See Flushing the system (page 50) .
Waste tank is pressurized	Replace the waste container cap. See Replacing the waste container cap (page 52) .
Poor sample preparation	Repeat sample preparation.
Sample was not diluted in the same fluid as the sheath fluid	Dilute the sample in the same fluid as you are using for sheath.
Old or contaminated QC particles	Make new QC samples and perform the quality control procedure again.
Instrument is not warmed up	Wait 30 minutes for the instrument to warm up.
Laser is not functioning	Contact BD Biosciences.
Optical alignment problem	Contact BD Biosciences.

Electronics troubleshooting

Introduction

This topic describes possible problems and recommended solutions for BD FACSCelesta electronics issues.

"Cytometer Disconnected" in cytometer window

Possible causes	Recommended solutions
Cytometer power is off	Turn on the cytometer main power.
Communication failure between workstation and cytometer	<ol style="list-style-type: none">1. In BD FACSDiva software, select Cytometer > Connect.2. If connecting does not work, restart the cytometer. Turn the cytometer off, wait 1 minute, and turn on the cytometer main power.3. If connecting still does not work, contact BD Biosciences.

9

Detector array configurations

This chapter covers the following topics:

- [Fluorescence spectra \(page 128\)](#)
- [About configuration maps \(page 131\)](#)
- [About the configuration \(page 132\)](#)
- [Base configuration polygon maps \(page 134\)](#)

Fluorescence spectra

Introduction

This topic shows sample emission spectra from common fluorochromes, as well as the more common laser excitation lines. This information is useful for designing multicolor panels. An interactive fluorescence viewer is available at bdbiosciences.com. You can also look for training by selecting Support > Training.

Designing multicolor panels

The BD FACSCelesta flow cytometer is designed specifically for multicolor research. Results depend on the excitation and emission spectra of the individual dye, the number of fluorescently labeled binding sites on the cell, as well as spectral overlap and spillover to other detectors. For more information about designing multicolor panels, see *Selecting Reagents for Multicolor Flow Cytometry* (Part No. 23-9538-02).

Example laser and dye interactions

The following figure shows the emission spectra of some common dyes, based on laser excitation. In many cases, a given dye can be excited by multiple laser wavelengths, yielding different emission intensities.

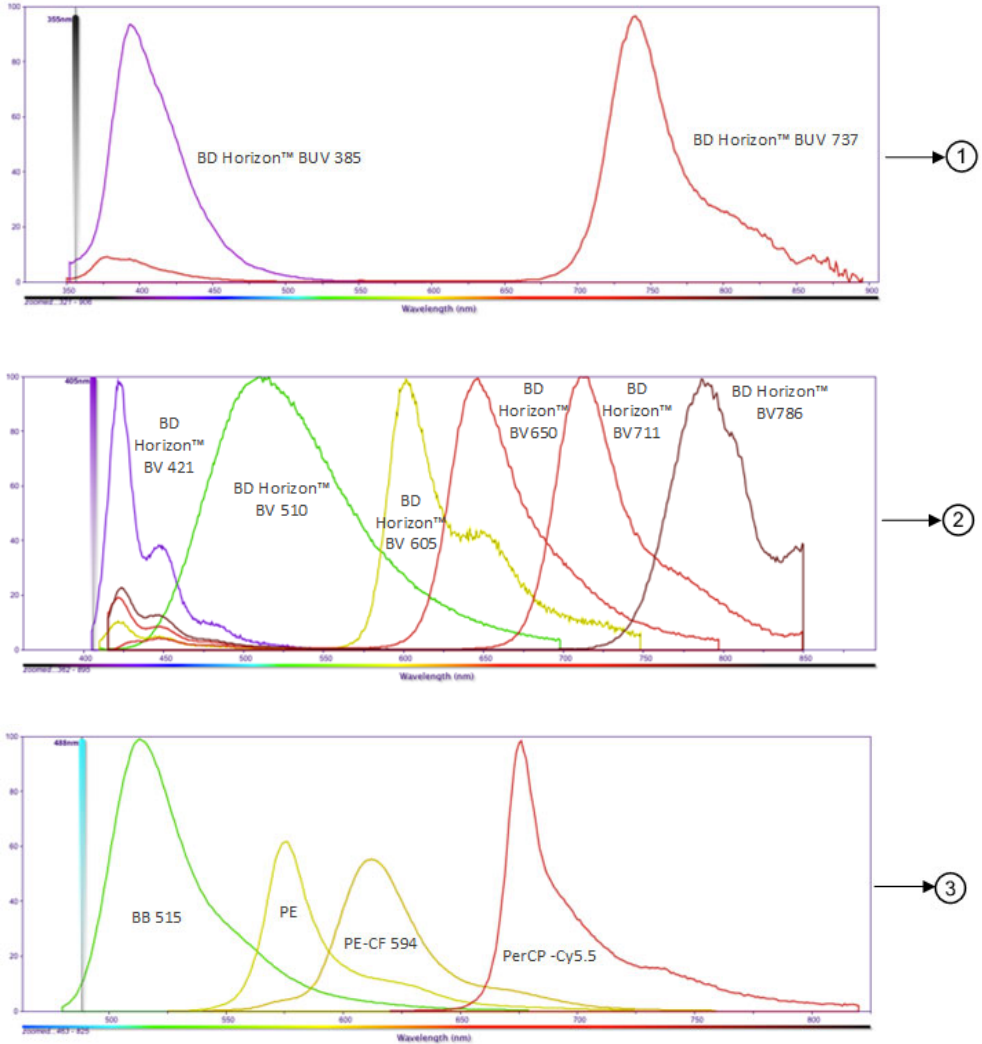

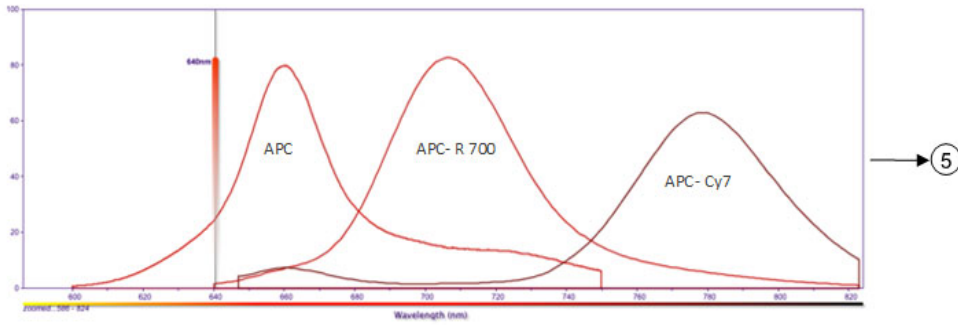
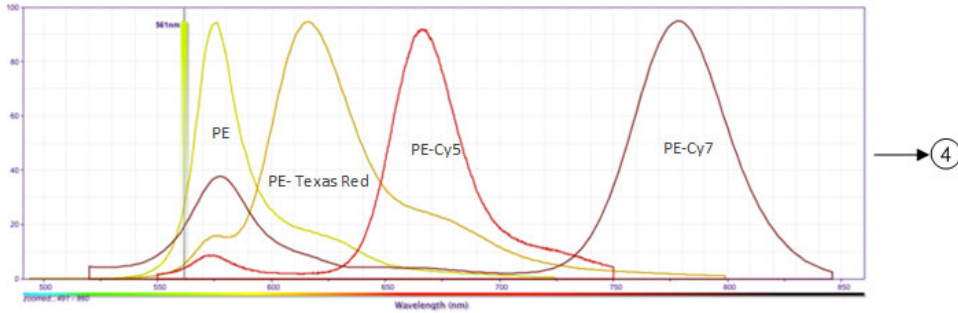

No	Definition
1	UV (355 nm)
2	Violet (405 nm)
3	Blue (488 nm)
4	Yellow-Green (561 nm)
5	Red (640 nm)

About configuration maps

Introduction

This topic describes the filter and mirror arrangements in the detector arrays.

Filter and mirror arrangement

The filters are arranged in the detector array to steer progressively shorter wavelengths of light to the next detector in the array. The longest wavelength should be in the A position and the shortest wavelength should be in the last position used.

There should not be any empty slots for any laser being used. Always use a blank optic holder.

If a slot is filled with a filter or mirror, an identifying number appears in that position on the configuration map. If a slot is filled with a blank optic holder, that position on the configuration map is unlabeled.

About the configuration

Introduction This section describes the configuration options available with the BD FACSCelesta flow cytometer.

Four available configurations The configuration for a BD FACSCelesta flow cytometer supports detectors, filters, and mirrors for up to three lasers to provide up to 12-color detection.

The following table explains the laser configuration set up in the BD FACSCelesta flow cytometer.

Configuration	Violet laser emission	Violet fluorescent detectors	Blue laser emission	Blue fluorescent detectors	Optional third laser emission	Optional third laser detectors
2 laser BV	405	6	488	4	-	-
3 laser BVUV	405	6	488	4	355	2
3 laser BVYG	405	6	488	2	571	4
3 laser BVR	405	5	488	4	640	3

Base configuration The BD FACSCelesta flow cytometer has one base configuration at installation. The following image shows a default base cytometer configuration.

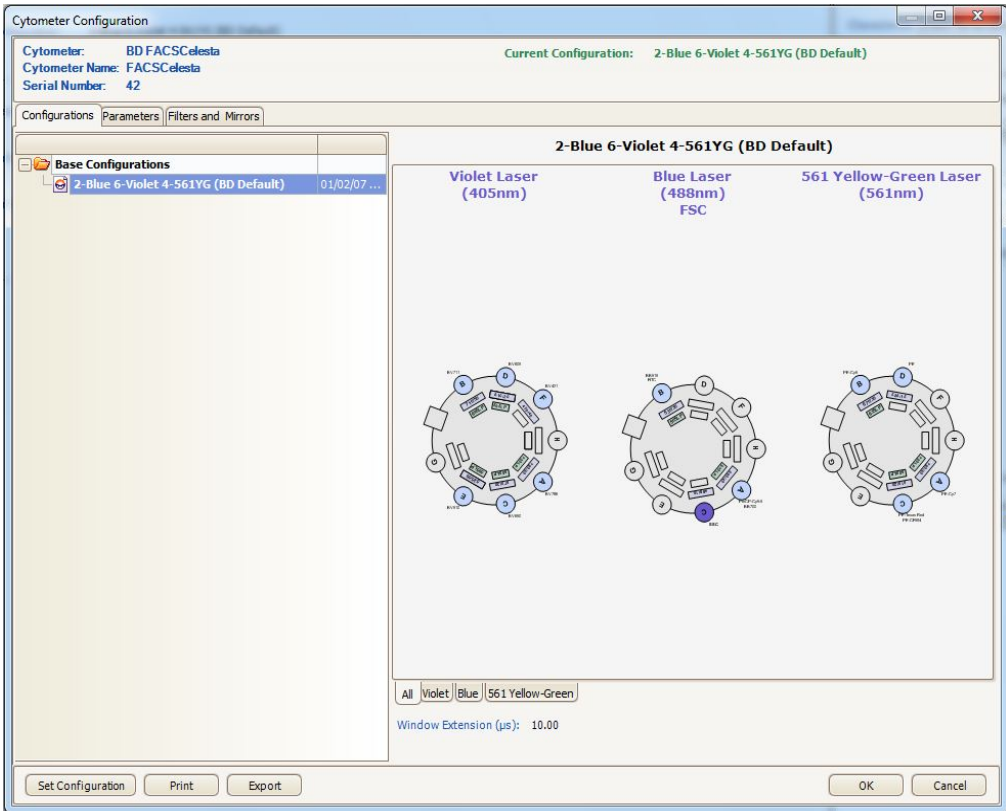

More information

- [Verifying the configuration and user preferences \(page 64\)](#)
- [Base configuration polygon maps \(page 134\)](#)

Base configuration polygon maps

Introduction

This section describes how filters and mirrors are arranged for standard polygon configurations.

About the maps

The tables in this section show the detectors, filters, and mirrors used in each configuration, and recommended fluorochromes for each detector. The word “blank” indicates that a blank optical holder should be used instead of an optic holder containing a mirror or filter. A dash (—) indicates that no slot exists for a mirror in that detector position.

Four-color blue laser configuration

The following map shows the four-color configuration for the 488-nm blue laser. This laser configuration is found in the BVR, BVUV, and BV BD FACSCelesta flow cytometers.

Detector	LP mirror	BP filter	Fluorochromes
A	670	695/40	PerCP-Cy5.5
B	600	610/20	PE-Texas Red®, PE-CF594
C	550	575/25	PE
D	505	530/30	FITC, BB515
E	Blank	488/10	SSC

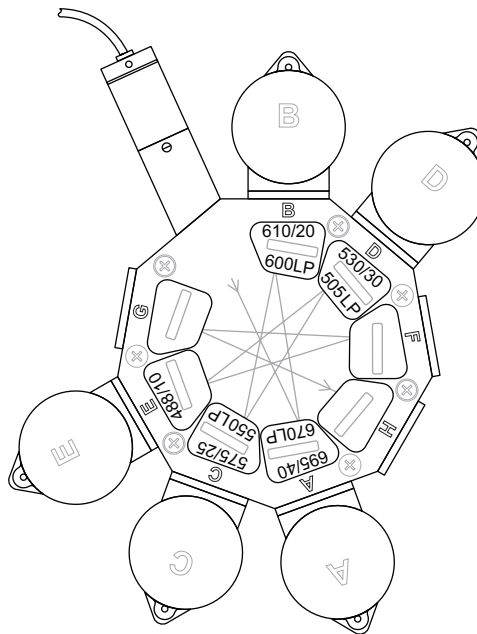

Six-color violet laser configuration

The following map shows the six-color configuration for the 405-nm violet laser. This laser configuration is found in the BVYG, BVUV, and BV BD FACSCelesta flow cytometers.

PMT	LP mirror	BP filter	Fluorochromes
A	750	780/60	BV786
B	690	710/50	BV711
C	655	670/30	BV650
D	595	610/20	BV605
E	505	525/50	BV510
F	Blank	450/40	BV421

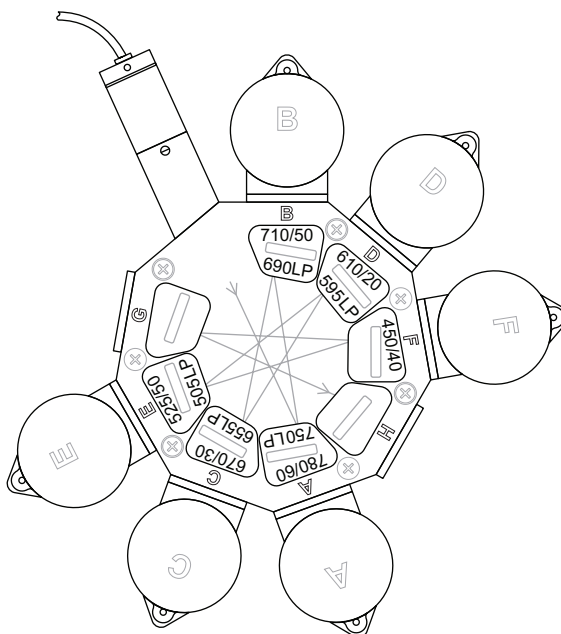

Two-color ultra violet laser configuration

The following map shows the two-color configuration for the 355-nm ultra violet laser. This laser configuration is found in the BVUV BD FACSCelesta flow cytometer.

PMT	LP mirror	BP filter	Fluorochromes
A	690	740/35	BUV737
B	Blank	379/28	BUV395

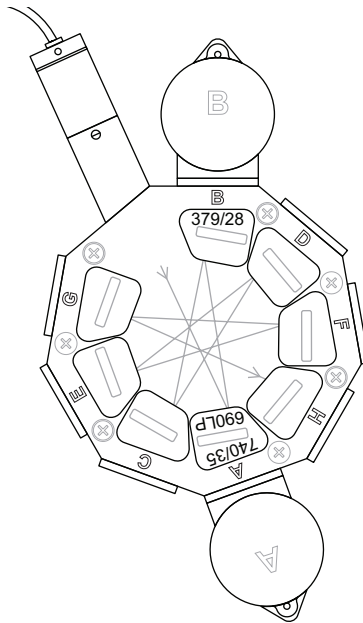

Two-color blue laser configuration

The following map shows the two-color configuration for the 488-nm blue laser. This laser configuration is found in the BVYG BD FACSCelesta flow cytometer.

PMT	LP mirror	BP filter	Fluorochromes
A	670	695/40	PerCP-Cy5.5
B	505	530/30	FITC, BB515
C	Blank	488/10	SSC

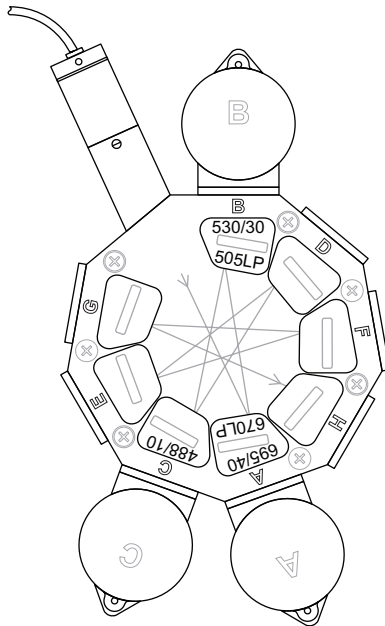

Three-color red laser configuration

The following map shows the three-color configuration for the 640-nm red laser. This laser configuration is found in the BVR BD FACSCelesta flow cytometer.

PMT	LP mirror	BP filter	Fluorochromes
A	750	780/60	APC-Cy7
B	690	730/45	APC-R700
C	Blank	670/30	APC

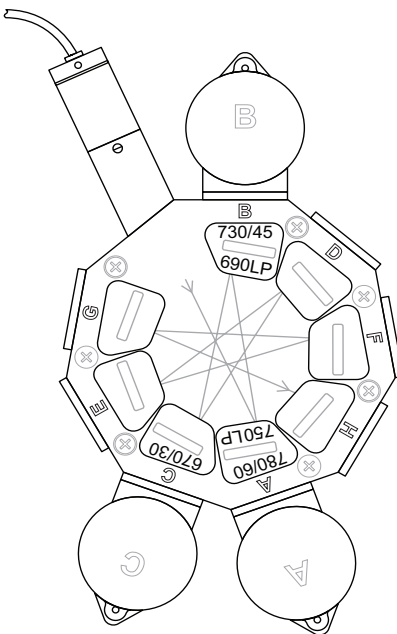

Four-color yellow-green laser configuration

The following map shows the four-color configuration for the 571-nm yellow-green laser. This laser configuration is found in the BVYG BD FACSCelesta flow cytometer.

PMT	LP mirror	BP filter	Fluorochromes
A	750	780/60	PE-Cy7
B	635	670/30	PE-Cy5
C	600	610/20	PE-Texas Red, PE-CF594
D	Blank	586/15	PE

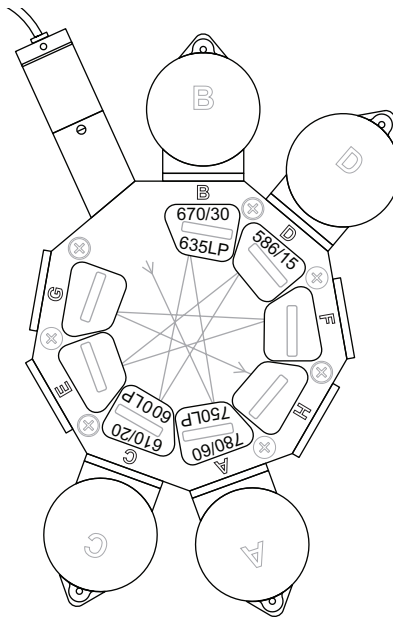

Five-color violet laser configuration

The following map shows the five-color configuration for the 405-nm violet laser. This laser configuration is found in the BVR BD FACSCelesta flow cytometer.

PMT	LP mirror	BP filter	Fluorochromes
A	750	780/60	BV786
B	655	670/30	BV650
C	595	610/20	BV605
D	505	525/50	BV510
E	Blank	450/40	BV421

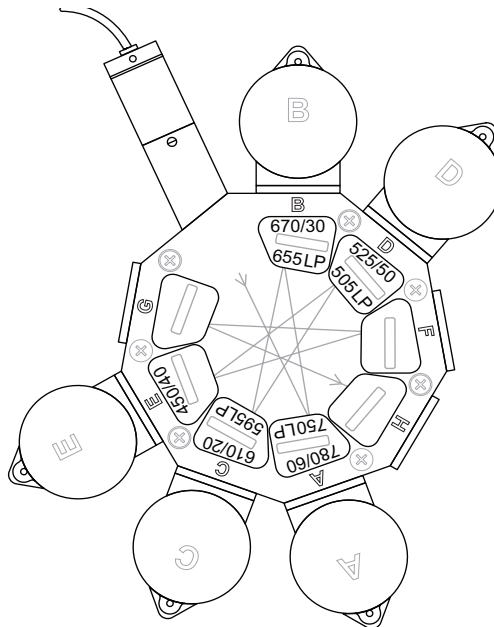

More information

- [About the configuration \(page 132\)](#)

This page intentionally left blank

10

Supplies and consumables

This chapter covers the following topics:

- [Ordering information \(page 144\)](#)
- [Beads \(page 144\)](#)
- [Reagents \(page 145\)](#)
- [Equipment \(page 146\)](#)

Ordering information

To order spare parts and consumables from BD Biosciences:

- Within the US, call (877) 232-8995.
- Outside the US, contact your local BD Biosciences customer support representative.

Worldwide contact information can be found at bdbiosciences.com.

Beads

Introduction

This topic lists the QC and CS&T beads available.

QC particles

Particle	Laser	Supplier	Catalog No.
SPHERO™ Rainbow Calibration Particles (8 peaks)	Blue, Violet, Yellow-Green and Red	BD Biosciences	559123
SPHERO Ultra Rainbow Fluorescent Particles (single peak)	Blue, Violet, Yellow-Green and Red	Spherotech, Inc.	URFP-30-2
BD DNA QC Particles	Blue (488 nm)	BD Biosciences	349523

CS&T beads

Bead	Laser	Supplier	Catalog No.
BD FACSDiva 2.0 CS&T research beads	<ul style="list-style-type: none"> • UV (355 nm) • Violet (405 nm) • Blue (488 nm) • Red (640 nm) • Yellow-green (561 nm) 	BD Biosciences	<ul style="list-style-type: none"> • 655050 (50 tests) • 655051 (150 tests)

Reagents

Reagent	Supplier	Catalog No.
BD FACSDiva sheath fluid	BD Biosciences	342003
BD FACSTM sheath solution with surfactant (recommended for use with the HTS option)	BD Biosciences	336524 (USA) 336911 (Europe)
Monoclonal antibodies	BD Biosciences	See the BD Biosciences Product Catalog or the BD Biosciences website (bdbiosciences.com)
BD FACSTM lysing solution	BD Biosciences	349202
BD Detergent Solution Concentrate	BD Biosciences	660585

Reagent	Supplier	Catalog No.
BD FACSClean solution	BD Biosciences	340345
Dyes and fluorochromes	BD Biosciences, Life Technologies, or Sigma	–
Chlorine bleach (5% sodium hypochlorite)	Clorox® or other major supplier (to ensure that the bleach is at the correct concentration and free of particulate matter)	–

Equipment

Equipment item	Supplier	Catalog No.
Bal seal	BD Biosciences	343509
O-ring, sample tube		343615
Sheath filter assembly		345734
Falcon polystyrene test tubes, 12 x 75-mm	Corning	352008

Index

Numerics

- 355-nm near-UV laser 137
- 405-nm violet laser 136, 141
- 488-nm blue laser 135, 138
- 571-nm yellow-green laser 140
- 640-nm red laser 139

A

- acridine orange (AO) 47
- air bubbles, removing 35
- alarm
 - waste container 27
- analysis
 - data 86
 - immunophenotyping 91
 - reusing 97
 - saving 97
- antibodies 102
- AO *See* acridine orange
- application settings
 - applying 87
 - creating 77
- arm, tube support 25
- aspiration (sample), rapid 119
- assistance, technical 13

B

- Bal seal
 - ordering 146
 - replacing 56

- bandpass (BP) filters
 - detector array placement 29
 - theory 107
- base configurations 134
- BD Detergent Solution Concentrate 48
- BD FACSClean solution 146
- BD FACSDiva software *See* software
- BD FACSThroughput sheath fluid 145
- BD FACSThroughput solution 35
- BD FACSThroughput supply system 32, 49
- BD High Throughput Sampler (HTS) 26
- blank optical holders 41
- bleach 46, 146
- BP *See* bandpass filters
- bubbles, removing air 36
- buttons
 - fluid control 21
 - sample flow rate control 22

C

- calculating compensation 83
- capacity, waste container 27
- cleaning solutions 46
- compensation
 - calculating 83
 - control tubes 80
 - recording settings 81
 - theory 109
- components
 - sheath container *shown* 34
 - sheath filter *shown* 54

- waste container *shown* 38
- computer system, about 30
- configuration
 - BD FACSDiva 64
- containers
 - sheath 27, 33
 - waste 27, 38, 40
- control panel, cytometer 19
- controls
 - fluidics 19
 - single-stained 63, 86
- conventions
 - safety symbols 11
- creating
 - analysis objects 91
 - global worksheets 87
 - statistics view 91
- CS&T particles 145
- CV, troubleshooting 125
- cytometer 17
 - configuration 42, 64
 - disconnect error 126
 - setup 62
 - starting 32
 - troubleshooting 118

D

- Daily cleaning 47
- DAPI, cleaning after using 47
- data
 - analyzing 86, 91
 - gating 91
 - recording 86, 88
- debris, excessive 124
- detector arrays 28
- detectors 30
- dichroic mirrors
 - theory 108
- digital data 17
- digital electronics 114

- Diva software *See* software
- DNA, flow rate for analysis 101
- droplet containment system 26

E

- electronics
 - digital 114
 - laser controls 115
 - pulse 112
 - pulse measurements 113
 - threshold 114
 - troubleshooting 126
- emission duration 112
- event rate
 - erratic 123
 - high 122
 - low 122
 - zero 119, 121
- excessive debris 124
- excitation wavelength 102
- experiments
 - creating 72
 - immunophenotyping 87
 - sample optimization 72
 - specifying parameters 73

F

- FACSFlow sheath fluid 145
- FACSFlow solution 35
- Falcon tubes 119
- filters, optical
 - bandpass (BP) 29, 107
 - dichroic *See* dichroic mirrors
 - longpass (LP) 104, 105
 - notch 104
 - shortpass (SP) 104, 106
 - theory 104
- filters, sheath
 - attaching new 55

- replacing 54
- FITC and Stokes shift 103
- fixed-alignment lasers 17
- flow cell
 - draining 40
 - fluidics 100
- flow rate control buttons 22
- fluid control buttons
 - PRIME 21
 - RUN 21
 - STANDBY 21
- fluidics
 - description 20, 100
 - flow rate control 22
 - flushing system 50
 - priming 40
 - removing air bubbles 36
 - run mode 21
 - sample injection port (SIP) 25
- fluidics controls, cytometer 19
- fluidics interconnect 37
- fluorescence
 - defined 102
 - emission 112
- fluorescence signal, none 121
- fluorochromes
 - compensation theory 109
 - emission spectra 103
 - measured 42
 - role in light emission 102
- flushing the system 50
- forward scatter (FSC) 102
- FSC *See* forward scatter

G

- gating data 91
- global worksheets
 - analyzing data 91
 - creating 87
 - previewing data 86, 97

H

- hazard symbol definitions 11
- Help, accessing 11
- High Throughput Sampler (HTS) 26
- hydrodynamic focusing 100

I

- immunophenotyping
 - analysis 91
 - experiment 87
 - hydrodynamic focusing 101

L

- lasers
 - options 28
 - performance check 67
 - quality control (QC) particles 144
- longpass (LP) filters
 - defined 104
 - theory 105
- LP *See* longpass filters

M

- maintenance
 - Bal seal 56
 - cytometer shutdown 49
 - sample tube O-ring 58
 - schedule 47
 - scheduled 50
 - sheath filter 54
 - system flush 50
- mirrors, dichroic longpass (LP) filter 29

N

- notch filters 104

O

- online Help 11
- optic holder 41
- optics
 - components 28
 - configuration 64, 66
 - dichroic mirrors 108
 - filters 28, 104
- optimization, sample 62
- ordering spare parts 144
- O-ring
 - ordering 146
 - replacing 58
 - worn 118

P

- particles 144, 145
- PerCP, Stokes shift 102
- performance check 67, 68
- photodiode 30
- photomultiplier tubes (PMTs) 29
- PMT *See* photomultiplier tubes
- polygon
 - shown* 29
- population hierarchy 91
- PRIME, fluid control button 21
- priming fluidics system 40
- propidium iodide (PI) 47
- pulse
 - definition 112
 - measurements 113
 - processors 113

Q

- quality control (QC)
 - particles 144
 - troubleshooting 125

R

- recording
 - compensation settings 81
 - compensation tubes 80
 - data 86, 88
- removing air bubbles, filter 36
- replacing
 - Bal seal 56
 - sample tube O-ring 58
 - sheath filter 54
 - waste air filter 52, 60
- reusing analyses 97
- RUN
 - button orange 121
 - fluid control button 21

S

- safety symbol definitions 11
- safety symbols 11
- sample
 - optimization 62
 - optimization experiment 72
 - optimization, single-stained
 - controls 63, 86
- sample injection port (SIP)
 - components 25
 - hydrodynamic focusing 100
 - replacing Bal seal 56
 - replacing sample tube O-ring 58
- sample tube
 - injection 25
 - not fitting 119
 - requirements 119
- samples, running 88
- saving analyses 97
- scatter
 - light 102
 - parameter distortion 124
- setup, cytometer 62

sheath
 flow 100

sheath container
 components *shown* 34
 defined 27
 depressurize 34
 preparing 34

sheath filter
 components *shown* 54
 ordering 146
 removing air bubbles 35
 replacing 54

sheath fluid 100
 BD FACSTow sheath fluid 145

shortpass (SP) filters 104, 106

side scatter (SSC) 102

signals, amplifying 29

SIP *See* sample injection port

software
 cytometer control 10
 version 30

spare parts, ordering 144

spillover 109

SSC *See* side scatter

STANDBY, fluid control button 21

starting cytometer 32

statistics views 91

Stokes shift 102

support, technical 13

T

technical assistance 13

thiazole orange (TO) 47

threshold, defined 114

TO *See* thiazole orange

troubleshooting
 cytometer 118
 electronics 126

tubes
 Falcon 119

requirements 119

U

user preferences 66

W

waste air filter
 component *shown* 38

waste container 27
 alarm 27
 capacity 27
 components *shown* 38
 defined 27
 emptying 38

workstation, about 30

